

SENATOR

Catalogue 2024

Senator® writing instruments have been produced in the heart of Germany for 100 years. Durability, sustainability, and reliability are the driving forces behind our commitment –making us a great partner for your advertising success.



NEW

MELBI

**Sustainable in 3 ways:
biobased, recycled
and climate-neutral**



kössinger
Mugs. Branded for you.

rou bill
Metal Pens. Branded for you.

senator
Made in Germany. Since 1920.

Valid from January 1, 2024

With this price list all previous prices and conditions lose their validity. All prices are industrial prices and are to be understood as recommended selling price in euro per piece, ex works, excluding VAT. Whilst our catalogues are prepared with utmost care SENATOR GmbH cannot guarantee the completeness and accuracy of the information provided.

Our general terms apply. You will find these at www.senator.com

SENATOR

MADE IN GERMANY

Senator has stood for quality and reliability for over 100 years. We are just as committed to these attributes as we are to the essential issue of responsibility for our environment and future generations.

Our claim:

- **Longevity**
We develop products with a long shelf life for your customers' lasting advertising success
- **Sustainability**
For us, superior ecological footprint of our products compared to imported products is the right path to a healthy future
- **Stability**
Regular certifications ensure that we are constantly improving



Quality, stability
and awareness in
one hand.



MADE IN GERMANY



COMPLETE VALUE CHAIN IN GERMANY

All senator® plastic pens are fully produced in Germany using 100% Green electricity. For us, "Made in Germany" goes far beyond mere advertising and encompasses the entire value chain from **design and development, injection moulding, assembly and printing to logistics and quality assurance**. This means we know exactly which raw materials go into every single writing instrument.

Your advantages with senator®:

- Short transport distances and proximity to the market
- Safe and durable products
- High and uniform quality standards
- Extensive know-how with experienced employees
- Flexibility in product development

With each of our writing instruments, we achieve a leading CO₂ footprint in the industry per metre of writing length, because **in terms of ecological footprint, a product "Made in Germany" clearly exceeds other imported products.**

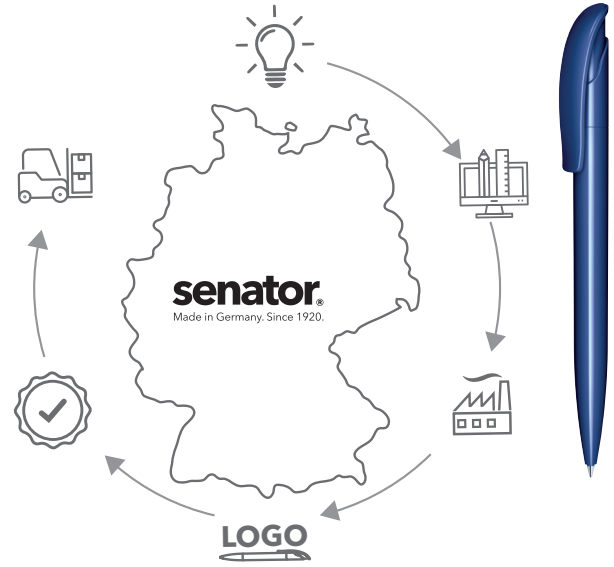

Senator® products are always the safe choice and fulfil all legal requirements. To us, the BSCI and Sedex membership is as self-evident as the certification according to ISO 9001 and 14001.



SENATOR® IS CLIMATE NEUTRAL

A healthy environment plays a major role for us. That is why we pay special attention to sustainable materials and production processes, ecological compatibility, waste avoidance, resource conservation and recycling. For example, we only purchase green electricity from hydropower and at the same time invest in electricity-saving measures at our production site.

Another important step in holistic climate protection is the offsetting of greenhouse gases. For us, this means not only continuing our efforts to reduce them, but also recording unavoidable greenhouse gas emissions and offsetting them

through climate protection projects. For this reason, Senator GmbH is a climate-Neutral company since 2021.

With the climate Neutrality of our company, we support both regional and global climate protection projects. In this way, we also promote the achievement of the global Sustainable Development Goals, such as the fight against poverty or the improvement of living conditions in emerging and developing countries.



PRODUCT RANGE WRITING INSTRUMENTS



Melbi



Liberty Skeyo Bio Nature Plus Super Hit

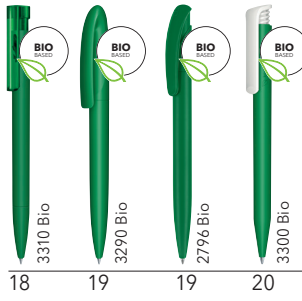

Super Hit Trento Liberty Challenger Evoxx

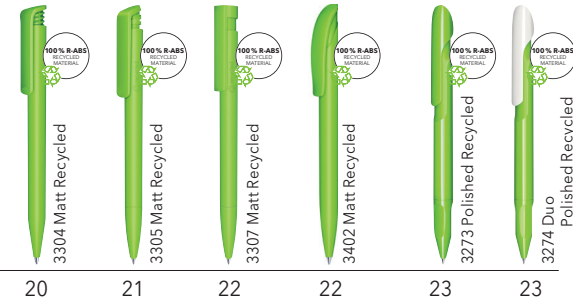

QR Code Pens



Dart

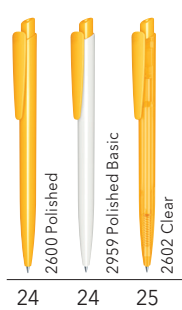

Super Hit

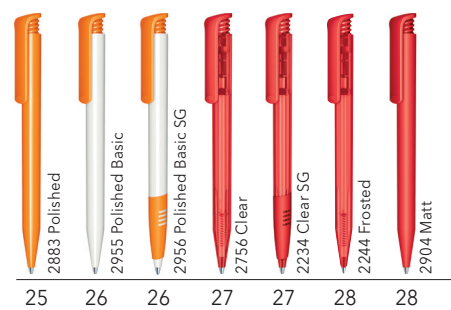

Liberty

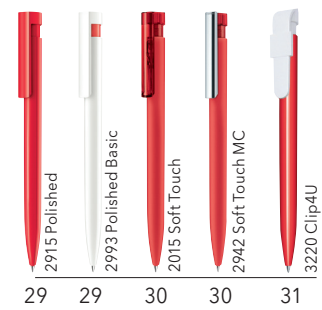

Challenger

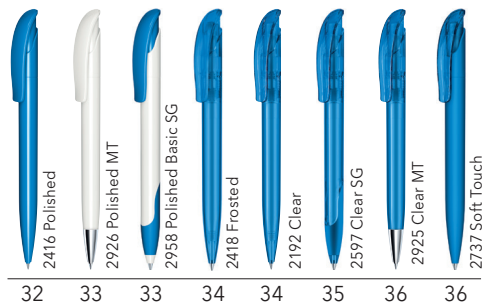

Bridge

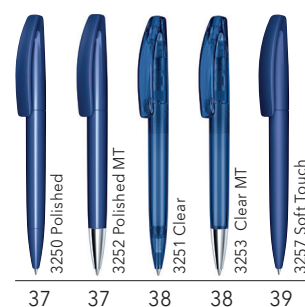

Headliner



Point



New Spring



Polar



Signer Liner



Refills



PRODUCT RANGE WRITING INSTRUMENTS



Arvent



Phenix



Attract



Galant



Arctic



Star Tec



Image

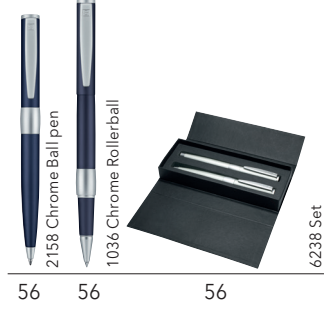
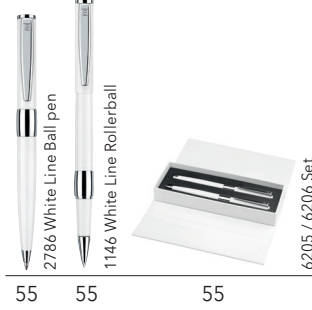
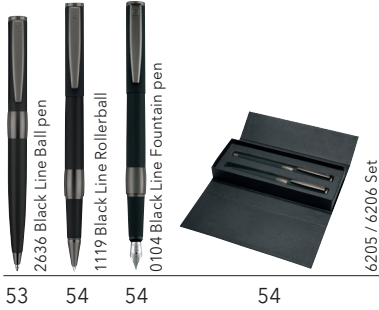

Nautic

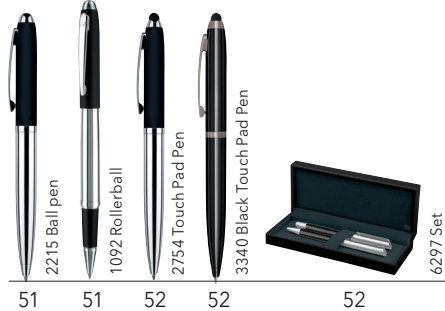

Carbon

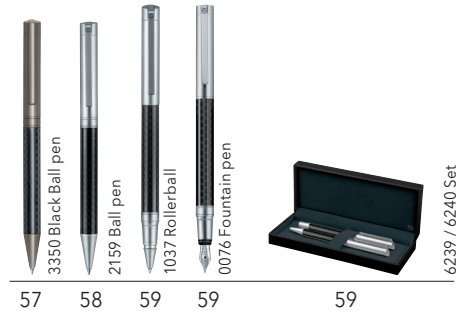

Tizio

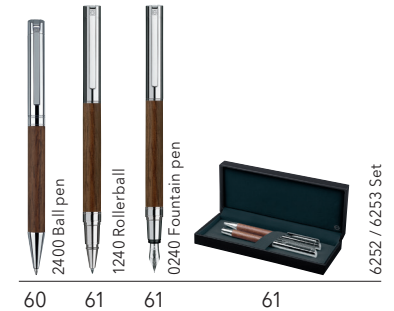

CASES



PRODUCT RANGE MUGS



Amity

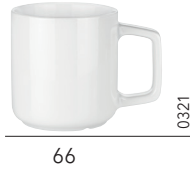

66

0321

Frieda

NEW



66

K011

Charisma



67

0915

Prime



67

0341

Elite



68

0912

Elegant



68

0381

Maxi Mug



69

0344

Appeal



69

0928

TABLEWARE

Fancy



70

0965



70

0964



71

0920



71

0966 / 0993 / 0994



72

0951

senator[®]
Made in Germany. Since 1920.

Maxim



84

0914



85

0907



85

0937



86

0977



86

0927/0997/0998



87

0952

kössinger[®]
Mugs. Branded for you.

PRODUCT RANGE OUTDOOR MUGS

King Can



74

0755

King Can Mini



75

0785

Trophy



75

0750

Carina White



77

K002

Carina Inside

NEW



77

K004

🚚 spring 2024

Carina

NEW



78

K003

🚚 spring 2024

Carina Glas

NEW



78

K016

🚚 spring 2024

Elektra White



80

K005

Elektra Inside



80

K006

🚚 spring 2024

Sophia

NEW



81

K015

🚚 spring 2024

Ennia White

NEW



81

K007

Ennia Inside

NEW



82

K008

🚚 spring 2024

Ennia Black Inside

NEW



82

K009

Cult



83

0911

Cosmos



83

0926

SUBLIMATION MUGS

Outdoor



76

0372

Carina White
(former Pics One)



77

0323

Cali
(former Pics Classic)



79

0362

Solid



79

0358

🚚 spring 2024

King Can



74

0765

Elektra White
(former Pics Elite)



80

0354

🚚 spring 2024

Elektra Inside
(former Pics Elite Inside)



80

0355

🚚 spring 2024

Cult
(former Pics Two)



83

0324

🚚 spring 2024

Cosmos



83

0356

🚚 spring 2024

CUSTOMISED COLOURS



MIX & MATCH SERVICE



Would you like a different colour combination for your favourite pen? Then the senator® Mix & Match service is just right for you. Combine the colours of our catalogue products freely according to your wishes and your corporate design. Parts of the different finishes polished, matt, clear and frosted can also be freely combined with each other and even supplemented with a metal tip if available.

We produce all plastic parts ourselves. This means that we can produce and combine the parts in the corresponding colours for you from a quantity **of 10,000 pieces**. This opens up almost **limitless possibilities** for your very own personalised ball pens.

An example:

The Bridge model consists of 3 parts, each of which is available in 15 colours, with the tip additionally available in a metal version.

This opens up 3,600 possible combinations for this model. And all that **at no extra charge**.

We will also be happy to help you select your desired model. Please contact us.

Examples for Mix & Match combinations:

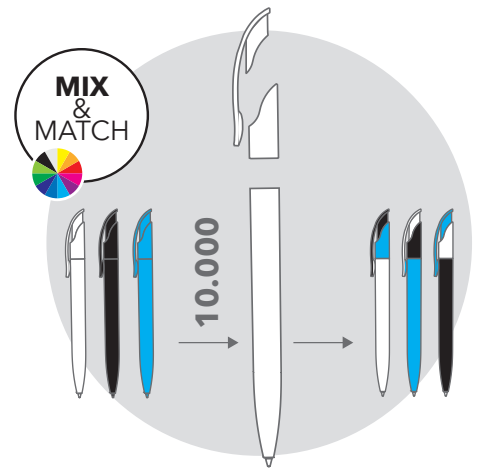

On request, you can combine selected plastic writing instruments in any of our standard colours from 10,000 pieces.

CUSTOMISED COLOURS



COLOURING ACCORDING TO PMS SPECIFICATION

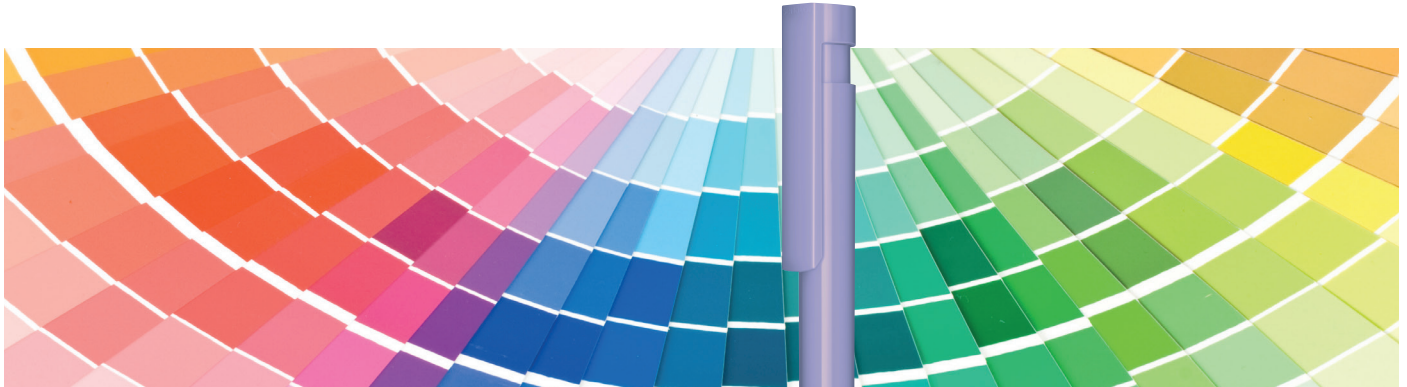

You can't find your desired colour among our catalogue products? Then use the senator® PMS service.

Tell us the PANTONE® number of your desired colour and we will produce the pen or just a specific part in your **very own personal shade**.

This is possible from a quantity of 10,000 pieces.

For approval we will send you a sample plate made in the desired colour.

Our colour references always refer to the PANTONE® Matching System, however we must point out that the product itself – because of different surfaces, lighting and materials – can differ from the colour tone printed on paper. This is why we cannot accept complaints for such deviations.

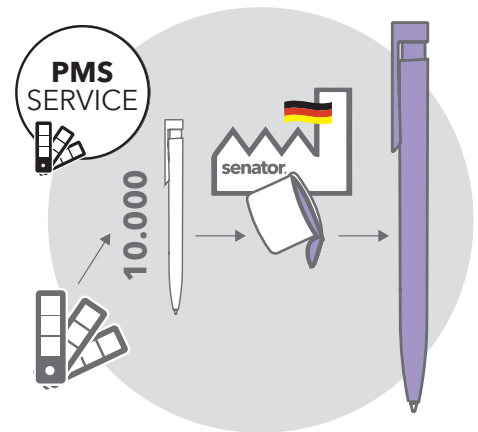

This service is available for all plastic pens.

For price information please see page 97.

Example from practice

Based on the colour of the year 2023, Hot Magenta, we developed our Evoxx Duo Polished Recycled in the PMS colour Rhodamine Red in the same year. This pen was even equipped with a pink refill. At a quantity of 10,000 pieces, we will also be happy to check the possibilities of customised production for you.

The customisable cardboard wallet ET157 (see page 62) supports your communication with an eye-catching appearance.



Art. No. 3273 Evoxx Polished Recycled in PMS colouring Rhodamine Red

FAST DELIVERY SERVICES

EXPRESS SERVICE (ONLINE PORTAL)



You can also simply place your orders online at any time. Including print approval. Fast and easy.

With the integrated configurator, you can create the finished print data at the same time. This saves further coordination processes and leaves you time to take care of your customers.

- We produce all articles within **5 working days**
- **Plastic pens from 50 pieces**, incl. digital print
- **Metal pens from 10 pieces**, incl. laser engraving
- **Mugs from 6 pieces**, incl. sublimation print
- **Free printed samples** also available.

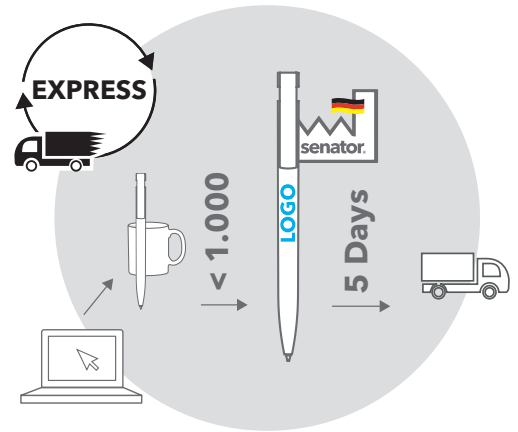

These models are available at my.senator.com:

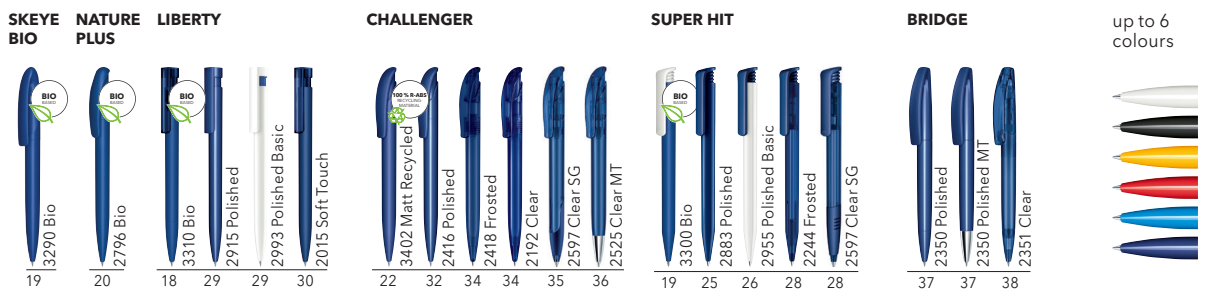

catalogue page:

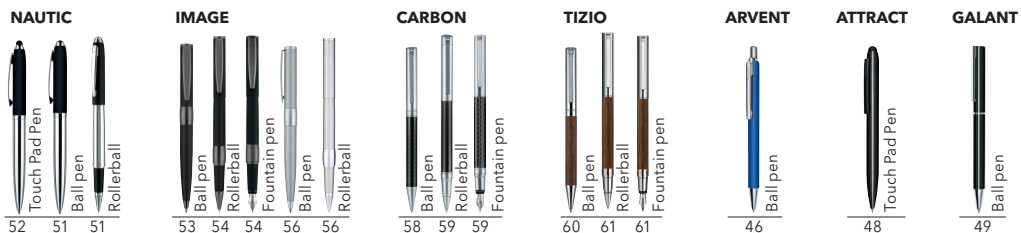

catalogue page:

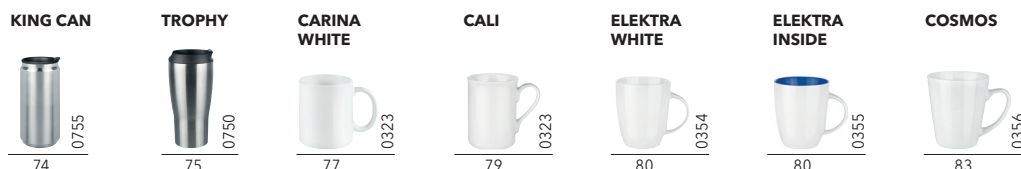

catalogue page:

FAST DELIVERY SERVICES



5,000 BALL PENS IN 5 DAYS



Take advantage of the unique senator® "5000 in 5" services. All of your orders for volumes of up to 5,000 pieces will be produced in Germany within 5 days, including up to 5-colour printing, packaging and ready for dispatch.

- **5 days production period** from approval of the artwork until 12:00 pm
- **Up to 5,000 ball pens**
- Up to **5 colour printing** (1c - 5c print, 1 position)
- Valid for all colours of the respective model
- Blue ink

For price information please see page 97.

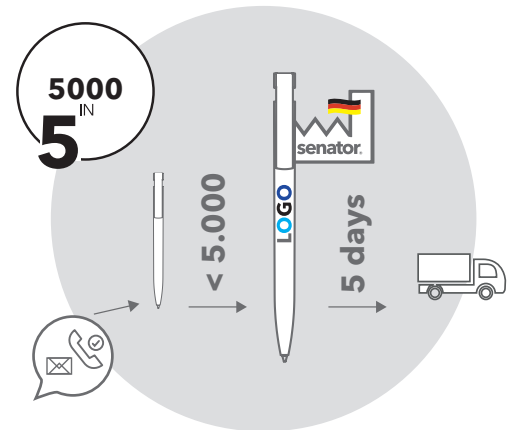

These models are available within our 5,000 in 5 service:

SKEYE BIO



NATURE PLUS



LIBERTY

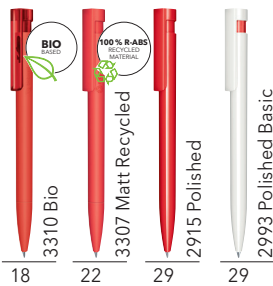

CHALLENGER

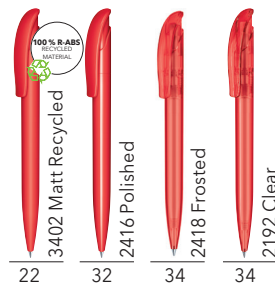

up to 15 colours

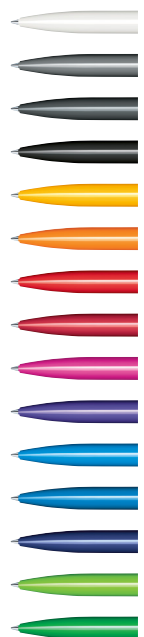

catalogue page:

SUPER HIT

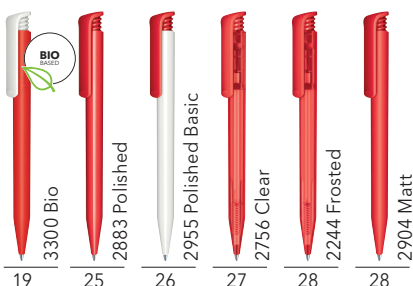

DART

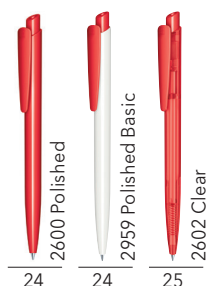

catalogue page:

CONNECTED PENS

BALL PENS WITH QR CODE



The senator® QR code ball pens offer you another option for a quick and contactless transfer of additional information.

QR codes have been established as a printing option at senator® for several years. Now, new and revolutionary applications can be linked with QR codes.

THE SENATOR® QR CODE PEN PACKAGE

1. Send us the **link of your choice** for your personalised QR code when placing your order.
2. We create your very own QR code, according to CI specifications and the **best possible readability**.
3. We print the QR code in best digital print quality, **without additional costs.***
4. The ball pen is then **immediately ready for use**.

EXAMPLE APPLICATIONS

- **Business cards**
With all important contact information including a call function
- **WiFi Connection**
With direct access to the corresponding Wi-Fi network (e.g. hotel industry)
- **Social Media Channels**
All information/news on your product and service range
- **Events**
Announce your trade fairs with all important data

*The QR code is equivalent to a digital print on the clip and can also be applied as part of your logo print at **no extra cost**.

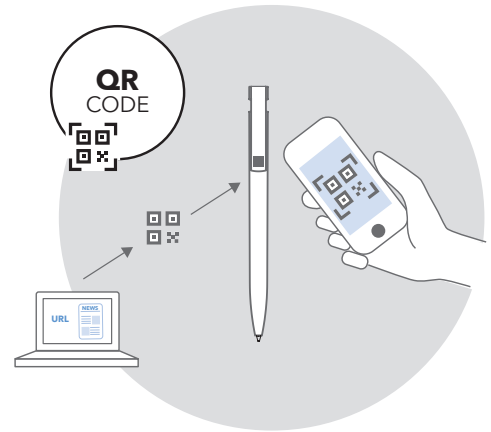

Also possible on coloured and transparent clips as long as the print colour is of sufficient contrast to the clip colour.

MODELS

These items can easily be provided with a QR code print on the clip.



REFILLS

FREE REPLACEMENT REFILL



Once the refill is empty, it is easy to extend its life span. We offer all users of our writing instruments from Europe the opportunity to order a free replacement refill via our website refills.senator.com. You only pay a shipping fee of 1 €.

This avoids waste, protects the environment and extends the advertising life of your ball pen many times over.

refills.senator.com

senator® magic flow

A high quality refill ensures a more pleasurable writing experience and guarantees higher levels of exposure and a better economic return for brands. As a specialist in plastics processing, we also produce our X20 and G2 plastic refills **in our own factory in Germany.**

The **senator® magic flow G2** refill belongs to the best of its class:

- **High class quality ball point**
- **Compliant** to ISO-12757-2 and tested under stringent quality criteria to the highest standards
- **In two sizes:**
1.0 mm for all who prefer a clear and fine line
1.4 mm for all those who love more ink flow and thus even smoother writing
- Thanks to the quality ballpoint and **premium-quality German ink** the writing is exceptionally smooth and even
- Our refill promise: **up to 5 years of writing power** of our G2 refills



8062 **senator® magic flow X20 refill (1.0 mm)**
Blue or black, writing length up to 2 km

8004 **senator® magic flow G2 refill (1.0 mm)**
Blue or black, writing length up to 5 km

8080 **senator® magic flow G2 refill (1.4 mm)**
Blue or black, writing length up to 3.5 km

8068 **senator® magic flow metal refill, G2**
Blue or black, writing length up to 8.5 km



BIOBASED PLASTICS AND RECYCLED PLASTICS



At senator® we actively follow the latest Research and Development in alternative materials to reduce the CO₂ footprint and see these developments very positively! Currently, we are already processing bio-based plastics from sugar cane in four successful ball pen models and producing five models from post-industrial recycled plastic.



BIOBASED PLASTICS (PLA)

We use a PLA based on renewable resources for our bio products. Our PLA is made from sugar cane. One of the most efficient raw materials for PLA production.



RECYCLED PLASTICS (R-ABS)

We use an ABS recompond based on >95% recycled material. This means reusing industrial production remnants and waste, returns and everyday products.

Source	Renewable raw material with a biobasis
Material basis	PLA (poly lactic acid from sugar cane)
Core characteristics	Pleasant feel and natural colours
CO ₂ footprint	CO ₂ reduced, as up to 85 % is organic / renewable



Genuinely recycled plastic from durable articles

ABS (Thermoplastic material)

High-quality surfaces

Up to 75 % less CO₂ compared to new ABS plastic





SENATOR

PENS

Produced 100% in our own factory in Germany, our writing instruments boast a far superior ecological footprint compared to imported products. Convincing. Versatile. Safe.

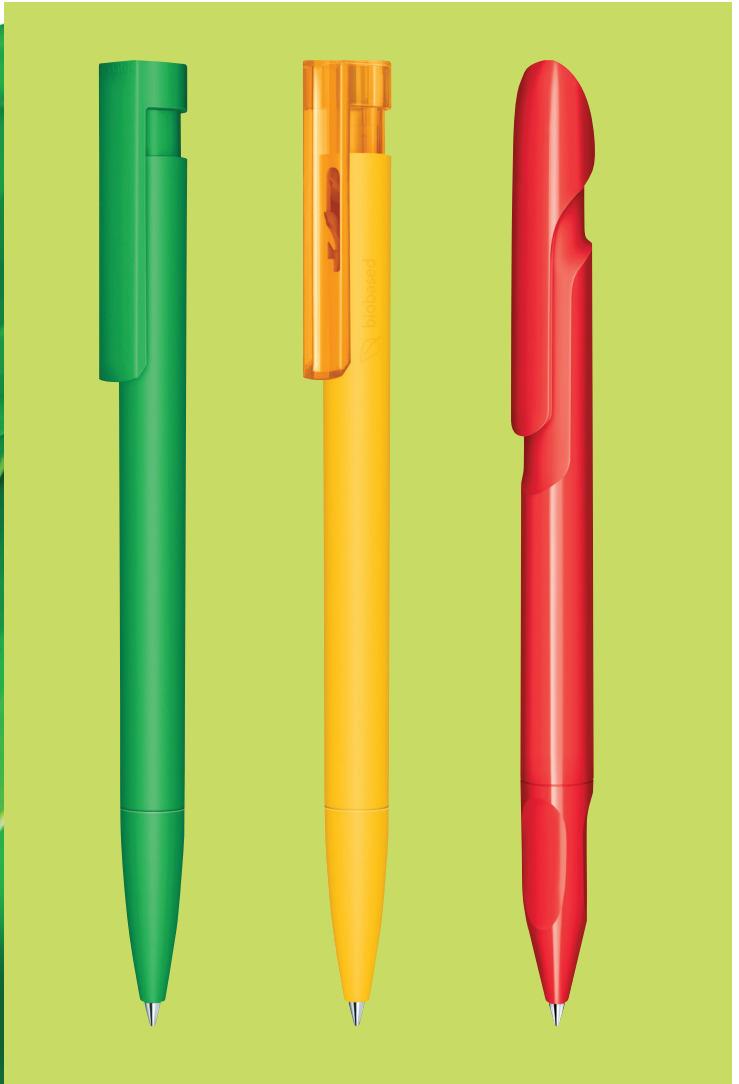

NEW



MELBI

A NEW APPROACH TO SUSTAINABILITY

Made from recycled production waste from the senator® Bio line, the new Melbi twist action ball pens is a pioneer in sustainability across the board.



Sustainable in 3 ways: biobased, recycled and climate-neutral

- Made from the production residues of senator® bio products
- Bio-based plastic waste from sugar cane
- Conserves resources as no additional raw materials are added
- Climate-neutral production in our own factory in Germany
- Free replacement refill, can be ordered online



senator®
bio pens



Reuse of the
generated
organic waste



Sustainable
further
processing



Resource-
conserving new
development

MELBI MATT BIO RECYCLED

Image scale 1:1

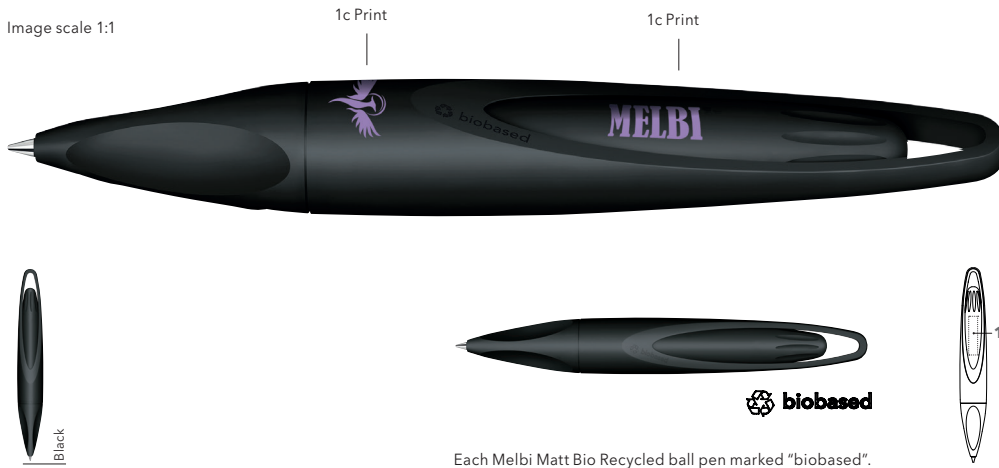

Each Melbi Matt Bio Recycled ball pen marked "biobased".

NEW



PENS

senator®
Made in Germany Since 1920

ART. NO. 3318

Twist action ball pen made from the recycled production waste of the senator® bio pens.

PLA-based bioplastic with a matt surface.
senator® magic flow G2 refill (1.0 mm),
writing length up to 5,000 m,
ink colour: blue or black

Note: The surface of products made of bio plastics may show slight irregularities.

BRANDING / AREA

Tube	1	1c - 2c Print	26 x 6 mm
Barrel	2	1c - 2c Print	8 x 10 mm



ET191

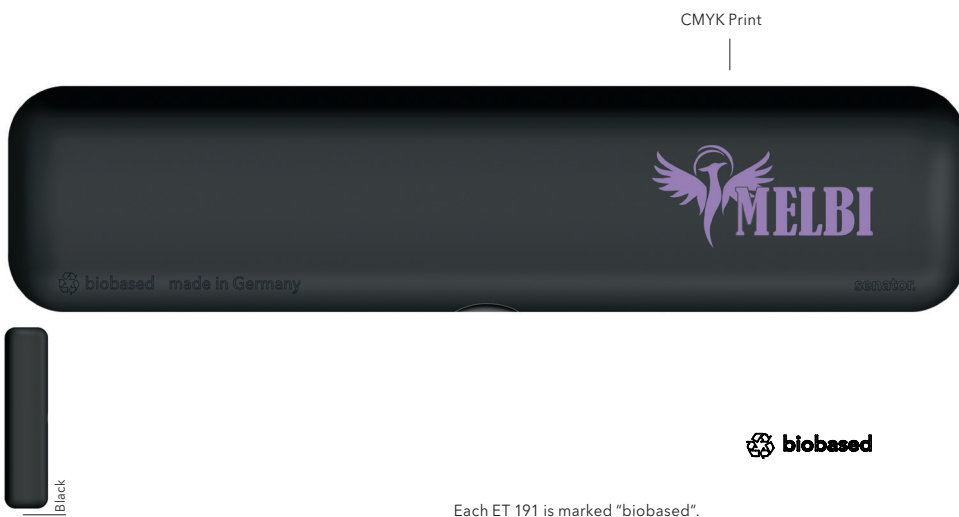

Each ET 191 is marked "biobased".

NEW



ART. NO. ET191

This case is made from the recycled production waste of the senator bio pens.

PLA-based bioplastic with a matt surface.

Note: The surface of products made of bio plastics may show slight irregularities.

BRANDING / AREA

Outside	1	CMYK Print	150 x 18 mm
---------	---	------------	-------------



LIBERTY BIO

TOP DESIGN WITH BIOPLASTICS.

A thoroughly durable concept: bio-based plastic, replaceable refill and trendy look. Environmental awareness hand in hand with good design.



LIBERTY BIO

Image scale 1:1

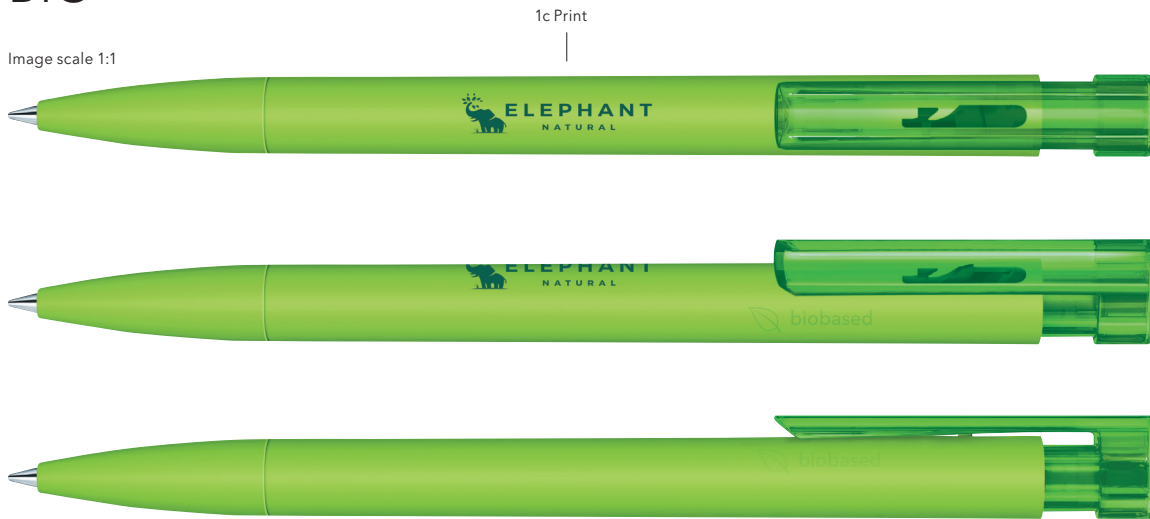

1c Print



Each Liberty Bio ball pen is engraved with "biobased" at the side.

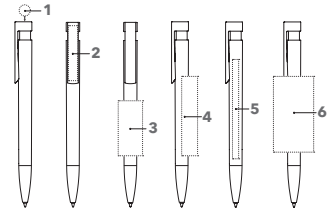

ART. NO. 3310

Push ball pen

Barrel and tip: bio-based material, matt surface, glossy transparent mid and clip surface, senator® magic flow G2 refill (1.0 mm), writing length up to 5,000 m, ink colour: blue or black
Note: The surface of products made of bio plastics may show slight irregularities.

SERVICES

Mix & Match: from 10,000 pieces, see page 8
PMS Service: from 10,000 pieces, see page 9

BRANDING / AREA

Cap	1	CMYK Print	Ø 9.5 mm
Clip	2	1c - 5c Print CMYK Print	35 x 6 mm
Barrel	3	1c - 5c Print	45 x 20 mm
	4	1c - 5c Print	65 x 13 mm
	5	CMYK Print	60 x 7 mm
	6	1c - 5c Print	60 x 30 mm (from 1,000 pieces)



NATURE PLUS BIO

Image scale 1:1



Each Nature Plus ball pen is marked at the side of the clip.

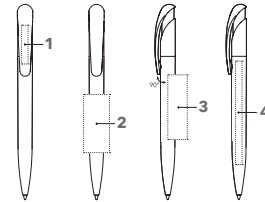

ART. NO. 2796

Push ball pen

bio-based material, matt surface,
senator® magic flow G2 refill (1.0 mm),
writing length up to 5,000 m,
ink colour: blue or black

Note: The surface of products made of bio plastics may show slight irregularities.

SERVICES

Mix & Match: from 10,000 pieces, see page 8

PMS Service: from 10,000 pieces, see page 9

BRANDING / AREA

Clip	1 1c - 5c Print CMYK Print	30 x 5 mm
Barrel	2 1c - 5c Print	45 x 20 mm
	3 1c - 5c Print	50 x 15 mm
	4 CMYK Print	80 x 7 mm



SKEYE BIO

Image scale 1:1



Each Skeye Bio ball pen is marked at the side of the clip.

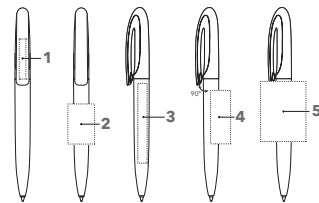

ART. NO. 3290

Twist ball pen

Bio-based material, matt surface,
senator® magic flow G2 refill (1.0 mm),
writing length up to 5,000 m,
ink colour: blue or black

Note:
The surface of products made of bio plastics may show slight irregularities.

SERVICES

Mix & Match: from 10,000 pieces, see page 8

PMS Service: from 10,000 pieces, see page 9

BRANDING / AREA

Clip	1 1c - 5c Print CMYK Print	35 x 6 mm
Barrel	2 1c - 5c Print	30 x 20 mm
	3 CMYK Print	50 x 7 mm
	4 1c - 5c Print	40 x 15 mm
	5 1c - 5c Print	45 x 34 mm (from 1,000 pieces)



SUPER HIT BIO

Image scale 1:1

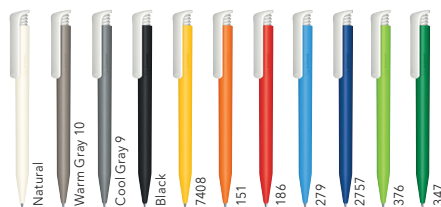

biobased

Each Super Hit Bio ball pen is engraved with "biobased" at the side.

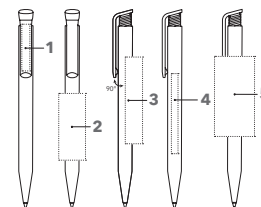

ART. NO. 3300

Push ball pen

Barrel: bio-based material, matt surface,

clip pusher: polished opaque, white,
senator® magic flow X20 refill (1.0 mm),
writing length up to 2,000 m,
ink colour: blue or black
Please note: The surface of products made of bio
plastics may show slight irregularities.

SERVICES

PMS Service: from 10,000 pieces, see page 9

BRANDING / AREA

Clip	1	1c - 5c Print CMYK Print	35 x 6 mm
Barrel	2	1c - 5c Print	50 x 20mm
	3	1c - 5c Print	65 x 13 mm
	4	CMYK Print	60 x 7 mm
	5	1c - 5c Print	60 x 30 mm (from 1,000 pieces)



SUPER HIT MATT RECYCLED

Image scale 1:1



recycled

Each Super Hit Matt Recycled ball pen is engraved with "recycled" at the side.

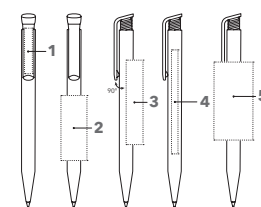

ART. NO. 3304

Push ball pen

Visible parts made from recycled material

Matt opaque barrel,
durable senator® magic flow X20 refill (1.0 mm),
writing length up to 2,000 m,
ink colour: blue or black

Please note that recycled material may show slight
colour variations.

SERVICES

PMS Service: from 10,000 pieces, see page 9

BRANDING / AREA

Clip	1	1c - 5c Print CMYK Print	35 x 6 mm
Barrel	2	1c - 5c Print	50 x 20 mm
	3	1c - 5c Print	65 x 13 mm
	4	CMYK Print	60 x 7 mm
	5	1c - 5c Print	60 x 30 mm (from 1,000 pieces)



TRENTO MATT RECYCLED

CLIMATE FRIEND.

If sustainability is as important to you as good design, then these senator® Recycled Pens are the models of your choice.



PENS

senator®
Made in Germany, Since 1920.

TRENTO MATT RECYCLED

Image scale 1:1

4c Print



Each Trento Recycled ball pen is engraved with "recycled" at the side.

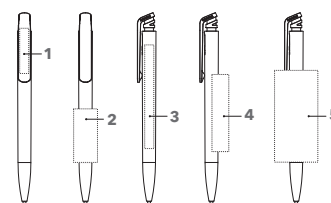

ART. NO. 3305

Push ball pen

Visible parts made from recycled material

Matt opaque barrel, durable senator® magic flow G2 refill (1.0 mm), writing length up to 5,000 m, ink colour: blue or black

Please note that recycled material may show slight colour variations.

SERVICES

Mix & Match: from 10,000 pieces, see page 8

PMS Service: from 10,000 pieces, see page 9

BRANDING / AREA

Part	Branding / Area	Dimensions
Clip	1c - 5c Print CMYK Print	35 x 6 mm
Barrel	2 1c - 5c Print	40 x 20 mm
	3 CMYK Print	60 x 7 mm
	4 1c - 5c Print	60 x 13 mm
	5 1c - 5c Print	60 x 30 mm (from 1,000 pieces)



LIBERTY MATT RECYCLED

Image scale 1:1

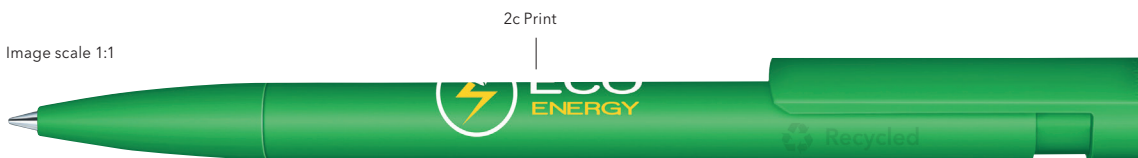

Each Liberty Matt Recycled ball pen is engraved with "recycled" at the side.

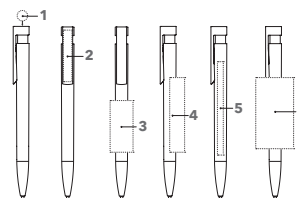

ART. NO. 3307

Push ball pen

Visible parts made from recycled material

Matt opaque barrel, durable senator® magic flow G2 refill (1.0 mm), writing length up to 5,000 m, ink colour: blue or black

Please note that recycled material may show slight colour variations.

SERVICES

Mix & Match: from 10,000 pieces, see page 8
PMS Service: from 10,000 pieces, see page 9

BRANDING / AREA

Cap	1 CMYK Print	Ø 9.5 mm
Clip	2 1c - 5c Print CMYK Print	35 x 6 mm
Barrel	3 1c - 5c Print	45 x 20 mm
	4 1c - 5c Print	65 x 13 mm
	5 CMYK Print	60 x 7 mm
	6 1c - 5c Print	60 x 30 mm (from 1,000 pieces)



CHALLENGER MATT RECYCLED

Image scale 1:1



Each Challenger Matt Recycled ball pen is printed with "Recycled Material" on the back.

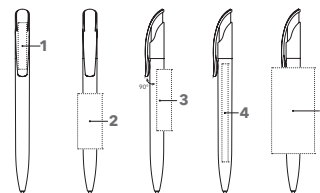

ART. NO. 3402

Push ball pen

Visible parts made from recycled material

Matt opaque body surface, durable senator® magic flow G2 refill (1.0 mm), writing length up to 5,000 m, ink colour: blue or black

Please note that recycled material may show slight colour variations.

SERVICES

Mix & Match: from 10,000 pieces, see page 8
PMS Service: from 10,000 pieces, see page 9

BRANDING / AREA

Clip	1 1c - 5c Print CMYK Print	35 x 7 mm
Barrel	2 1c - 5c Print	45 x 20 mm
	3 1c - 5c Print	50 x 12 mm
	4 CMYK Print	60 x 7 mm
	5 1c - 5c Print	60 x 35 mm (from 1,000 pieces)



EVOXX POLISHED RECYCLED

Image scale 1:1



Each Evoxx Recycled ball pen is printed with "Recycled Material" on the back.

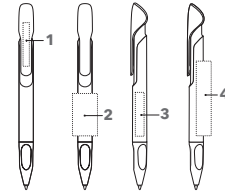

ART. NO. 3273

Push ball pen

Visible parts made from recycled material

Glossy opaque barrel with matt accents, durable senator® magic flow G2 refill, (1.0 mm), writing length up to 5,000 m, ink colour: blue or black

Please note that recycled material may show slight colour variations.

SERVICES

Mix & Match: from 10,000 pieces, see page 8

PMS Service: from 10,000 pieces, see page 9

BRANDING / AREA

Clip	1	1c - 5c Print CMYK Print	35 x 5 mm
Barrel	2	1c - 5c Print	28 x 20 mm
	3	CMYK Print	35 x 7 mm
	4	1c - 5c Print	55 x 18 mm



ClimatePartner.com/13772-1910-1001

EVOXX DUO POLISHED RECYCLED

Image scale 1:1



Each Evoxx Recycled ball pen is printed with "Recycled Material" on the back.

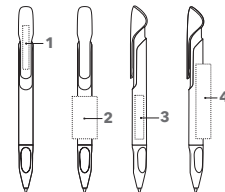

ART. NO. 3274

Push ball pen

Visible parts made from recycled material

Glossy opaque barrel with matt accents, durable senator® magic flow G2 refill (1.0 mm), writing length up to 5,000 m, ink colour: blue or black

Please note that recycled material may show slight colour variations.

SERVICES

Mix & Match: from 10,000 pieces, see page 8

PMS Service: from 10,000 pieces, see page 9

BRANDING / AREA

Clip	1	1c - 5c Print CMYK Print	35 x 5 mm
Barrel	2	1c - 5c Print	28 x 20 mm
	3	CMYK Print	35 x 7 mm
	4	1c - 5c Print	55 x 18 mm



ClimatePartner.com/13772-1910-1001

DART POLISHED

Image scale 1:1

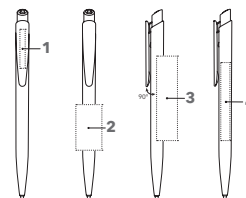

ART. NO. 2600

Push ball pen

Glossy opaque body and clip surface, senator® magic flow X20 refill (1.0 mm), writing length up to 2,000 m, ink colour: blue or black

SERVICES

Mix & Match: from 10,000 pieces, see page 8

PMS Service: from 10,000 pieces, see page 9

BRANDING / AREA

Clip	1 1c - 5c Print CMYK Print	20 x 6 mm
Barrel	2 1c - 5c Print	35 x 20 mm
	3 1c - 5c Print	65 x 12 mm
	4 1c - 5c Print	60 x 7 mm

DART POLISHED BASIC

Image scale 1:1

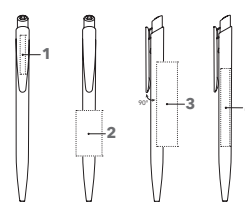
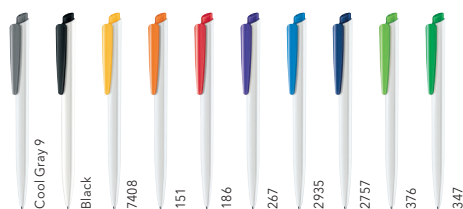

ART. NO. 2959

Push ball pen

Glossy opaque body and clip surface, white barrel, coloured clip, senator® magic flow X20 refill (1.0 mm), writing length up to 2,000 m, ink colour: blue or black

SERVICES

Mix & Match: from 10,000 pieces, see page 8

PMS Service: from 10,000 pieces, see page 9

BRANDING / AREA

Clip	1 1c - 5c Print CMYK Print	20 x 6 mm
Barrel	2 1c - 5c Print	35 x 20 mm
	3 1c - 5c Print	65 x 12 mm
	4 CMYK Print	60 x 7 mm

DART CLEAR

Image scale 1:1

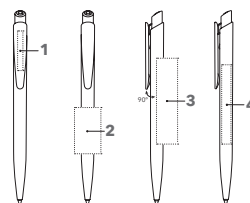

ART. NO. 2602

Push ball pen

Glossy transparent body surface,
glossy opaque clip,
senator® magic flow X20 refill (1.0 mm),
writing length up to 2,000 m,
ink colour: blue or black

SERVICES

Mix & Match: from 10,000 pieces, see page 8

PMS Service: from 10,000 pieces, see page 99

BRANDING / AREA

Clip	1 1c - 5c Print CMYK Print	20 x 6 mm
Barrel	2 1c - 5c Print	35 x 20 mm
	3 1c - 5c Print	65 x 12 mm
	4 CMYK Print	60 x 7 mm

SUPER HIT POLISHED

Image scale 1:1

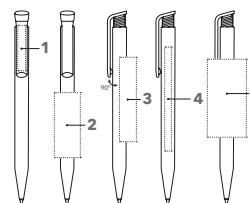
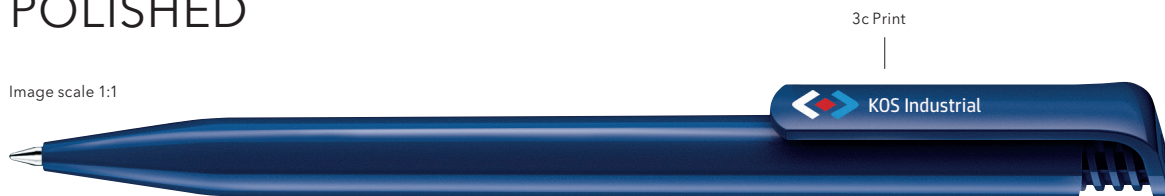

ART. NO. 2883

Push ball pen

Glossy opaque body and clip surface,
senator® magic flow X20 refill (1.0 mm),
writing length up to 2,000 m,
ink colour: blue or black

SERVICES

Mix & Match: from 10,000 pieces, see page 8

PMS Service: from 10,000 pieces, see page 9

BRANDING / AREA

Clip	1 1c - 5c Print CMYK Print	35 x 6 mm
Barrel	2 1c - 5c Print	50 x 20 mm
	3 1c - 5c Print	65 x 13 mm
	4 CMYK Print	80 x 7 mm
	5 1c - 5c Print CMYK Print on white barrel	60 x 30 mm (from 1,000 pieces)

SUPER HIT POLISHED BASIC

Image scale 1:1

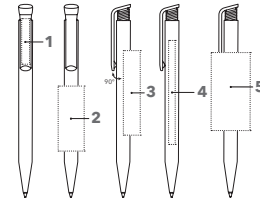

ART. NO. 2955

Push ball pen

Polished opaque body and clip surface, white barrel, coloured clip, senator® magic flow X20 refill (1.0 mm), writing length up to 2,000 m, ink colour: blue or black

SERVICES

PMS Service: from 10,000 pieces, see page 9

BRANDING / AREA

Clip	1	1c - 5c Print CMYK Print	35 x 6 mm
Barrel	2	1c - 5c Print	50 x 20 mm
	3	1c - 5c Print	65 x 13 mm
	4	CMYK Print	80 x 7 mm
	5	1c - 5c Print CMYK Print	60 x 30 mm (from 1,000 pieces)

SUPER HIT POLISHED BASIC SG

Image scale 1:1

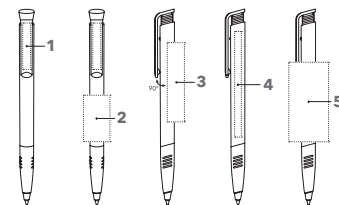

ART. NO. 2956

Push ball pen

Polished opaque body and clip surface, white barrel, coloured clip and soft grip zone, senator® magic flow X20 refill (1.0 mm), writing length up to 2,000 m, ink colour: blue or black

SERVICES

Mix & Match: from 10,000 pieces, see page 8

PMS Service: from 10,000 pieces, see page 9

BRANDING / AREA

Clip	1	1c - 5c Print CMYK Print	35 x 6 mm
Barrel	2	1c - 5c Print	35 x 20 mm
	3	1c - 5c Print	60 x 12 mm
	4	CMYK Print	80 x 7 mm
	5	1c - 5c Print	60 x 30 mm (from 1,000 pieces)

SUPER HIT CLEAR

Image scale 1:1

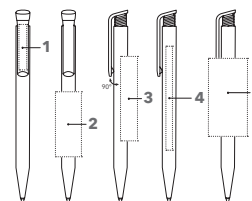

ART. NO. 2756

Push ball pen

Glossy transparent body surface and shiny opaque clip, senator® magic flow X20 refill (1.0 mm), writing length up to 2,000 m, ink colour: blue or black

SERVICES

Mix & Match: from 10,000 pieces, see page 8

PMS Service: from 10,000 pieces, see page 9

BRANDING / AREA

Clip	1	1c - 5c Print CMYK Print	35 x 6 mm
Barrel	2	1c - 5c Print	50 x 20 mm
	3	1c - 5c Print	65 x 13 mm
	4	CMYK Print	80 x 7 mm
	5	1c - 5c Print	60 x 30 mm (from 1,000 pieces)

SUPER HIT CLEAR SG

Image scale 1:1

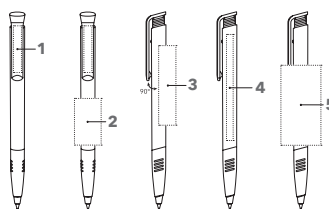
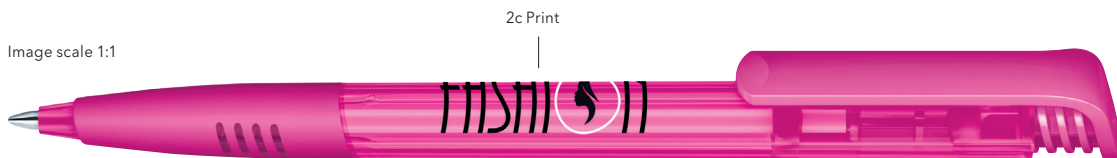

ART. NO. 2234

Push ball pen

Glossy transparent body surface and shiny opaque clip, coloured soft grip zone, senator® magic flow X20 refill (1.0 mm), writing length up to 2,000 m, ink colour: blue or black

SERVICES

Mix & Match: from 10,000 pieces, see page 8

PMS Service: from 10,000 pieces, see page 9

BRANDING / AREA

Clip	1	1c - 5c Print CMYK Print	35 x 6 mm
Barrel	2	1c - 5c Print	35 x 20 mm
	3	1c - 5c Print	60 x 12 mm
	4	CMYK Print	80 x 7 mm
	5	1c - 5c Print	60 x 30 mm (from 1,000 pieces)

SUPER HIT FROSTED

Image scale 1:1

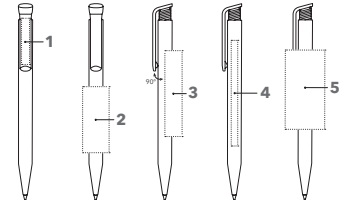

ART. NO. 2244

Push ball pen

Translucent shine-free body surface, glossy opaque clip, senator® magic flow X20 refill (1.0 mm), writing length up to 2,000 m, ink colour: blue or black

SERVICES

Mix & Match: from 10,000 pieces, see page 8

PMS Service: from 10,000 pieces, see page 9

BRANDING / AREA

Clip	1	1c - 5c Print CMYK Print	35 x 6 mm
Barrel	2	1c - 5c Print	50 x 20 mm
	3	1c - 5c Print	65 x 13 mm
	4	CMYK Print	80 x 7 mm
	5	1c - 5c Print	60 x 30 mm (from 1,000 pieces)

SUPER HIT

Image scale 1:1

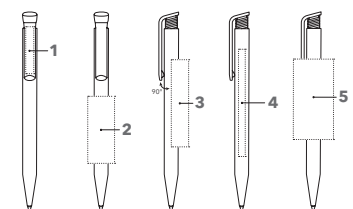

ART. NO. 2904

Push ball pen

Opaque, shine-free finish body surface, glossy opaque clip, senator® magic flow X20 refill (1.0 mm), writing length up to 2,000 m, ink colour: blue or black

SERVICES

Mix & Match: from 10,000 pieces, see page 8

PMS Service: from 10,000 pieces, see page 9

BRANDING / AREA

Clip	1	1c - 5c Print CMYK Print	35 x 6 mm
Barrel	2	1c - 5c Print	50 x 20 mm
	3	1c - 5c Print	65 x 13 mm
	4	CMYK Print	80 x 7 mm
	5	1c - 5c Print	60 x 30 mm (from 1,000 pieces)

LIBERTY POLISHED

Image scale 1:1

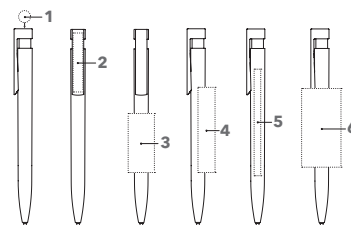

ART. NO. 2915

Push ball pen

Glossy opaque body and clip surface,
senator® magic flow G2 refill (1.0 mm),
writing length up to 5,000 m,
ink colour: blue or black

SERVICES

Mix & Match: from 10,000 pieces, see page 8

PMS Service: from 10,000 pieces, see page 9

BRANDING / AREA

Cap	1	CMYK Print	Ø 9,5 mm
Clip	2	1c - 5c Print CMYK Print	35 x 7 mm
Barrel	3	1c - 5c Print	45 x 20 mm
	4	1c - 5c Print	65 x 13 mm
	5	CMYK Print	80 x 7 mm
	6	1c - 5c Print CMYK Print on white barrel	60 x 30 mm (from 1,000 pieces)

LIBERTY POLISHED BASIC

Image scale 1:1

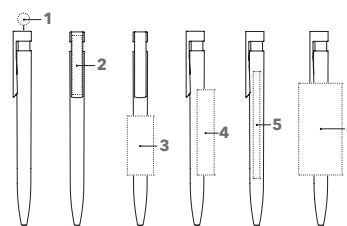
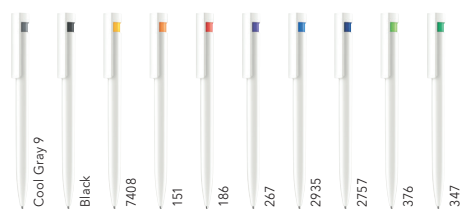

ART. NO. 2993

Push ball pen

Glossy opaque white barrel and clip surface,
coloured transparent mid part,
senator® magic flow G2 refill (1.0 mm),
writing length up to 5,000 m,
ink colour: blue or black

SERVICES

Mix & Match: from 10,000 pieces, see page 8

PMS Service: from 10,000 pieces, see page 9

BRANDING / AREA

Cap	1	CMYK Print	Ø 9,5 mm
Clip	2	1c - 5c Print CMYK Print	35 x 7 mm
Barrel	3	1c - 5c Print	45 x 20 mm
	4	1c - 5c Print	65 x 13 mm
	5	CMYK Print	80 x 7 mm
	6	1c - 5c Print CMYK Print	60 x 30 mm (from 1,000 pieces)

LIBERTY SOFT TOUCH

Image scale 1:1

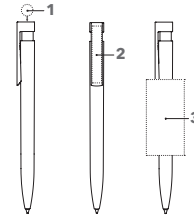

ART. NO. 2015

Push ball pen

Velvety body surface, glossy transparent mid and clip surface, senator® magic flow G2 refill (1.0 mm), writing length up to 5,000 m, ink colour: blue or black

SERVICES

Mix & Match: from 10,000 pieces, see page 8

PMS Service: from 10,000 pieces, see page 9

BRANDING / AREA

Cap	1	CMYK Print	Ø 9.5 mm
Clip	2	1c - 5c Print CMYK Print	35 x 7 mm
Barrel	3	1c - 5c Print	60 x 30 mm (from 1,000 pieces)

LIBERTY SOFT TOUCH MC

Image scale 1:1

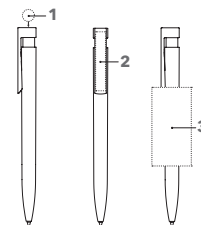

ART. NO. 2942

Push ball pen

Velvety body surface, glossy transparent mid and clip holder, metal clip, senator® magic flow G2 refill (1.0 mm), writing length up to 5,000 m, ink colour: blue or black

SERVICES

Mix & Match: from 10,000 pieces, see page 8

PMS Service: from 10,000 pieces, see page 9

BRANDING / AREA

Cap	1	CMYK Print	Ø 7.5 mm
Clip	2	Engraving	45 x 6 mm
Barrel	3	1c - 5c Print	60 x 30 mm (from 1,000 pieces)

LIBERTY CLIP4U

Image scale 1:1

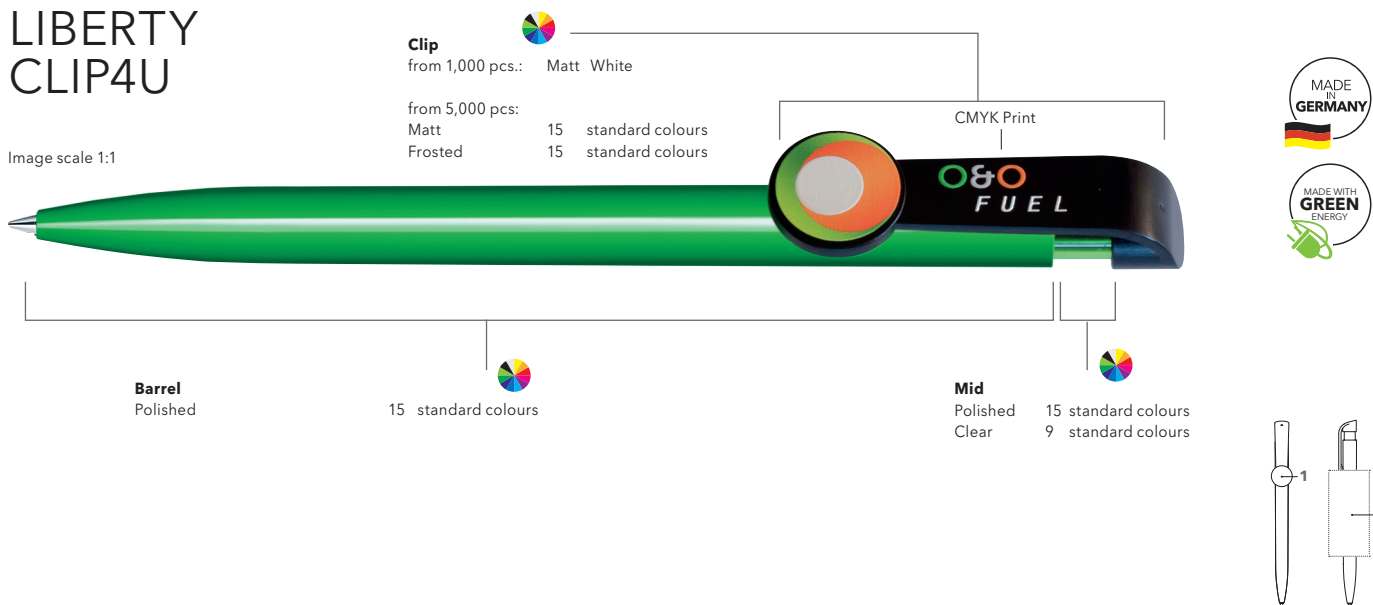

ART. NO. 3220

Push ball pen

Design your own clip shape or choose your favourite from available ones.
Free combination option of different colours.
senator® magic flow G2 refill (1.0 mm),
writing length up to 5,000 m,
ink colour: blue or black

SERVICES

PMS Service: from 10,000 pieces,
see page 9

BRANDING / AREA

Clip	1 CMYK Print	max 40,5 x 16 mm (depending on clip shape)
Barrel	2 1c - 5c Print CMYK Print on white barrel	60 x 30 mm (from 1,000 pieces)



CLIP 4U

Design your own clip shape. Contact us for more information.



STANDARD CLIP SHAPES WITHOUT TOOLING CHARGES

For these clip shapes we do not charge any tooling costs:

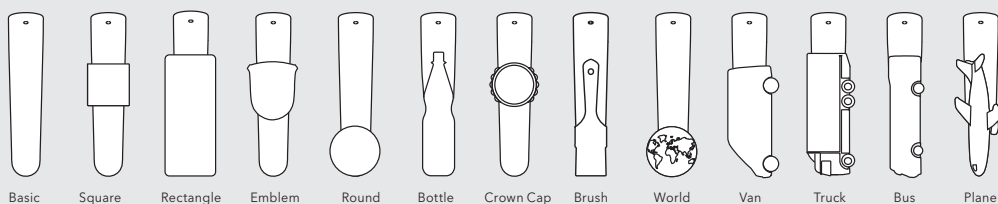

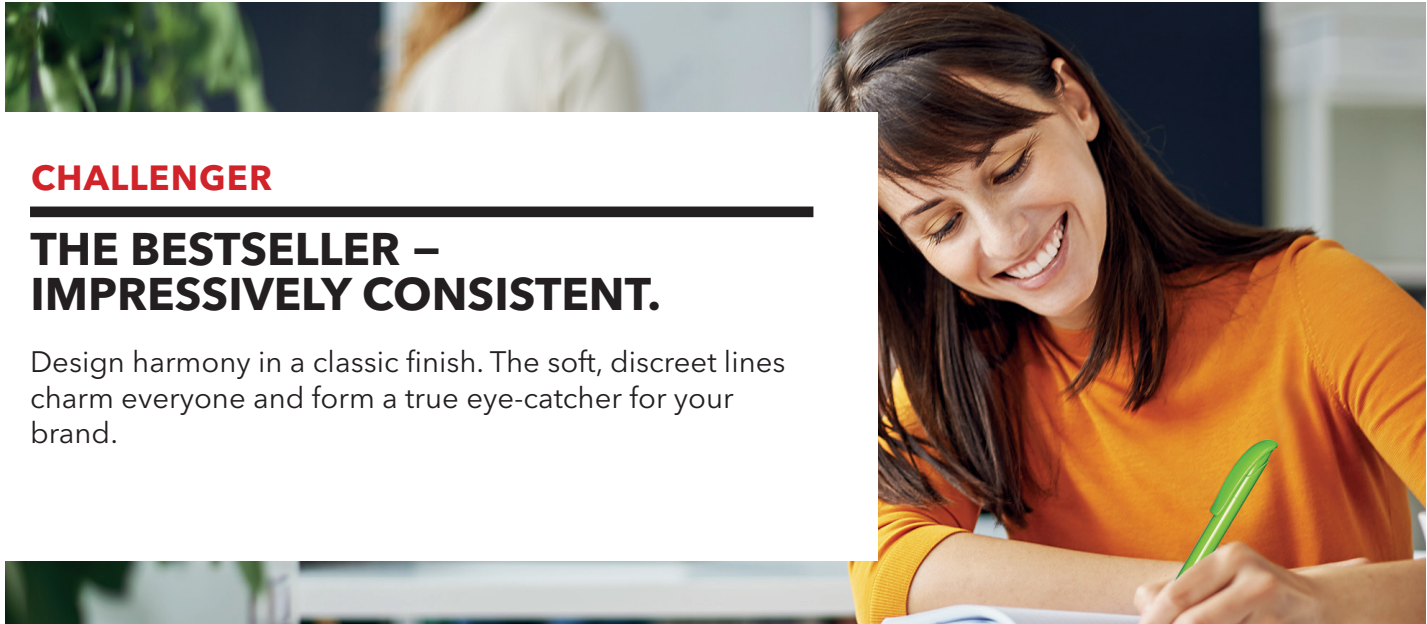

CHALLENGER

THE BESTSELLER – IMPRESSIVELY CONSISTENT.

Design harmony in a classic finish. The soft, discreet lines charm everyone and form a true eye-catcher for your brand.

CHALLENGER POLISHED

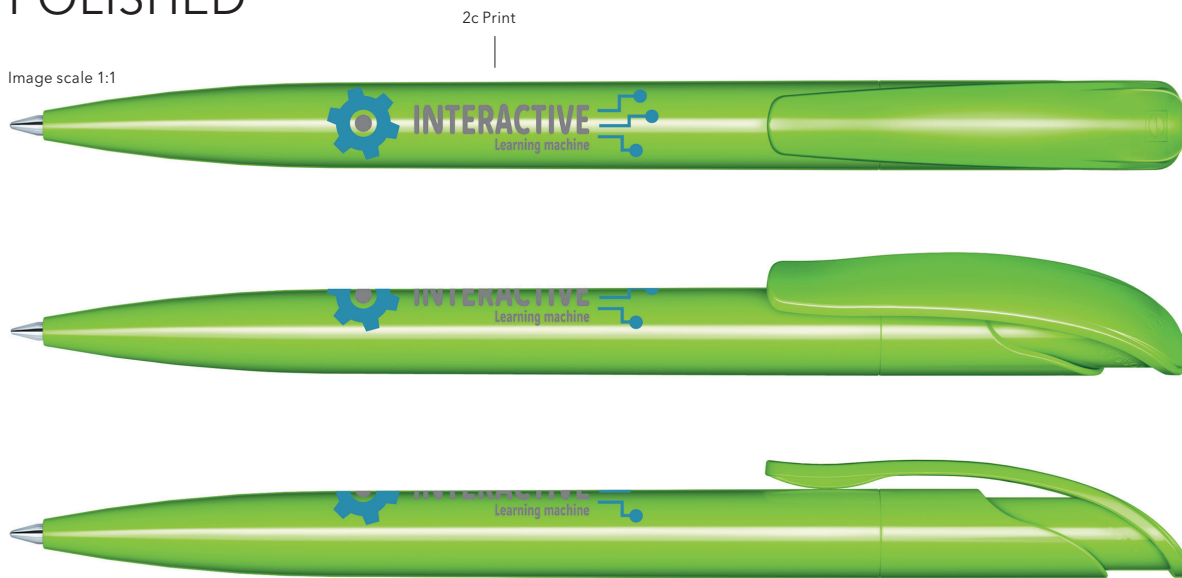

2c Print

Image scale 1:1

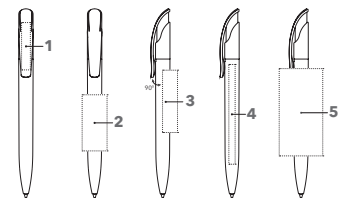

ART. NO. 2416

Push ball pen

Glossy opaque body and clip surface, senator® magic flow G2 refill (1.0 mm), writing length up to 5,000 m, ink colour: blue or black

SERVICES

Mix & Match: from 10,000 pieces, see page 8

PMS Service: from 10,000 pieces, see page 9

BRANDING / AREA

Clip	1	1c - 5c Print CMYK Print	35 x 7 mm
	2	1c - 5c Print	45 x 20 mm
Barrel	3	1c - 5c Print	50 x 12 mm
	4	CMYK Print	80 x 7 mm
	5	1c - 5c Print CMYK Print on white barrel	60 x 35 mm (from 1,000 pieces)

CHALLENGER POLISHED MT

Image scale 1:1

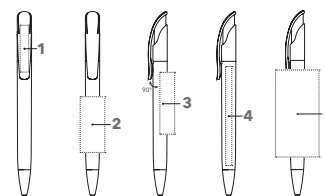

ART. NO. 2926

Push ball pen

Glossy opaque body and clip surface, glossy metal tip,
senator® magic flow G2 refill (1.0 mm),
writing length up to 5,000 m,
ink colour: blue or black

SERVICES

Mix & Match: from 10,000 pieces, see page 8

PMS Service: from 10,000 pieces, see page 9

BRANDING / AREA

Part	Print	Dimensions
Clip	1 1c - 5c Print CMYK Print	35 x 7 mm
Barrel	2 1c - 5c Print	45 x 20 mm
	3 1c - 5c Print	50 x 12 mm
	4 CMYK Print	80 x 7 mm
	5 1c - 5c Print CMYK Print on white barrel	60 x 35 mm (from 1,000 pieces)

CHALLENGER POLISHED BASIC SG

Image scale 1:1

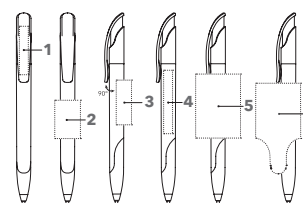
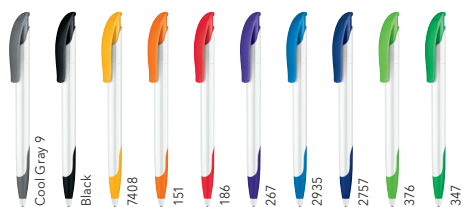

ART. NO. 2958

Push ball pen

Glossy opaque body and clip surface, white barrel, coloured clip and soft grip zone,
senator® magic flow G2 refill (1.0 mm),
writing length up to 5,000 m,
ink colour: blue or black

SERVICES

Mix & Match: from 10,000 pieces, see page 8

PMS Service: from 10,000 pieces, see page 9

BRANDING / AREA

Part	Print	Dimensions
Clip	1 1c - 5c Print CMYK Print	35 x 7 mm
Barrel	2 1c - 5c Print	30 x 20 mm
	3 1c - 5c Print	35 x 12 mm
	4 CMYK Print	60 x 7 mm
	5 1c - 5c Print	50 x 35 mm (from 1,000 pieces)
	6 CMYK Print	60 x 35 mm (from 1,000 pieces)

CHALLENGER FROSTED



Image scale 1:1

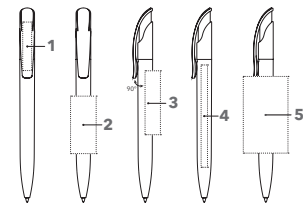

ART. NO. 2418

Push ball pen

Translucent shine-free body and clip surface, senator® magic flow G2 refill (1.0 mm), writing length up to 5,000 m, ink colour: blue or black

SERVICES

Mix & Match: from 10,000 pieces, see page 8
PMS Service: from 10,000 pieces, see page 9

BRANDING / AREA

Clip	1	1c - 5c Print CMYK Print	35 x 7 mm
Barrel	2	1c - 5c Print	45 x 20 mm
	3	1c - 5c Print	50 x 12 mm
	4	CMYK Print	80 x 7 mm
	5	1c - 5c Print	60 x 35 mm (from 1,000 pieces)

CHALLENGER CLEAR



Image scale 1:1

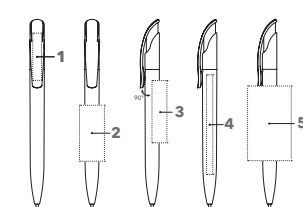

ART. NO. 2192

Push ball pen

Glossy transparent body and clip surface, senator® magic flow G2 refill (1.0 mm), writing length up to 5,000 m, ink colour: blue or black

SERVICES

Mix & Match: from 10,000 pieces, see page 8
PMS Service: from 10,000 pieces, see page 9

BRANDING / AREA

Clip	1	1c - 5c Print CMYK Print	35 x 7 mm
Barrel	2	1c - 5c Print	45 x 20 mm
	3	1c - 5c Print	50 x 12 mm
	4	CMYK Print	80 x 7 mm
	5	1c - 5c Print	60 x 35 mm (from 1,000 pieces)

CHALLENGER CLEAR SG

DESIGN HARMONY MEETS RELIABILITY.

A shiny transparent barrel, soft lines and a harmoniously integrated rubber grip zone make the senator® Best-Seller a favoured companion for everyday use.

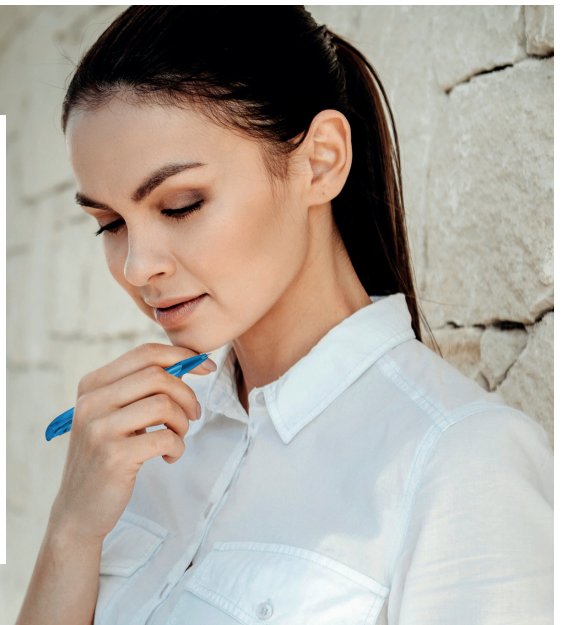

CHALLENGER CLEAR SG



Image scale 1:1

3c Print

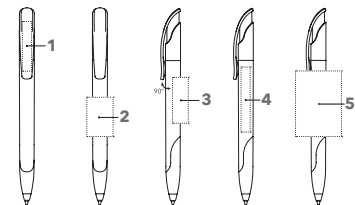

ART. NO. 2597

Push ball pen

Glossy transparent body and clip surface, coloured soft grip zone matching the barrel, senator® magic flow G2 refill (1.0 mm), writing length up to 5,000 m, ink colour: blue or black

SERVICES

Mix & Match: from 10,000 pieces, see page 8

PMS Service: from 10,000 pieces, see page 9

BRANDING / AREA

Part	Branding	Area
Clip	1 1c - 5c Print CMYK Print	35 x 7 mm
Barrel	2 1c - 5c Print	30 x 20 mm
	3 1c - 5c Print	35 x 12 mm
	4 CMYK Print	60 x 7 mm
	5 1c - 5c Print	50 x 35 mm (from 1,000 pieces)

CHALLENGER CLEAR MT

Image scale 1:1

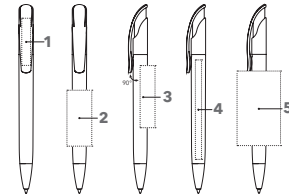

ART. NO. 2925

Push ball pen

Glossy transparent body and clip surface, glossy metal tip, senator® magic flow G2 refill (1.0 mm), writing length up to 5,000 m, ink colour: blue or black

SERVICES

Mix & Match: from 10,000 pieces, see page 8
PMS Service: from 10,000 pieces, see page 9

BRANDING / AREA

Clip	1 1c - 5c Print CMYK Print	35 x 7 mm
Barrel	2 1c - 5c Print	45 x 20 mm
	3 1c - 5c Print	50 x 12 mm
	4 CMYK Print	80 x 7 mm
	5 1c - 5c Print	60 x 35 mm (from 1,000 pieces)

CHALLENGER SOFT TOUCH

Image scale 1:1

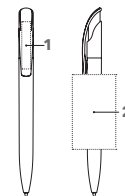

ART. NO. 2737

Push ball pen

Velvety body surface, transparent clip, senator® magic flow G2 refill (1.0 mm), writing length up to 5,000 m, ink colour: blue or black

SERVICES

PMS Service: from 10,000 pieces, see page 9

BRANDING / AREA

Clip	1 1c - 5c Print CMYK Print	35 x 7 mm
Barrel	2 1c - 5c Print	60 x 35 mm (from 1,000 pieces)

BRIDGE POLISHED

Image scale 1:1

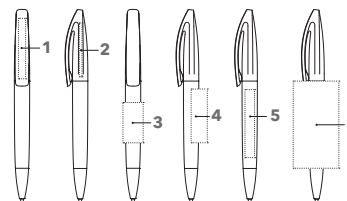
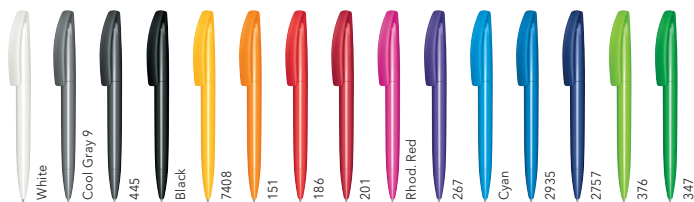
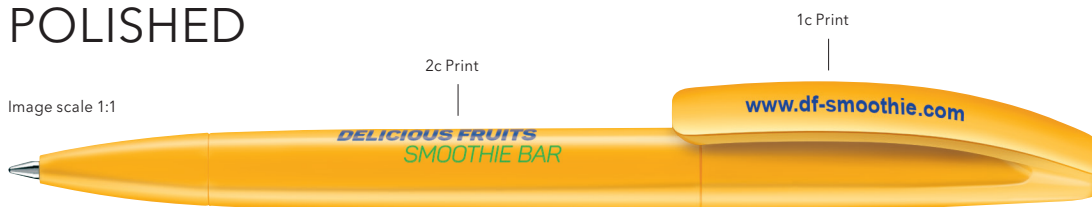

ART. NO. 3250

Twist ball pen

Glossy opaque body and clip surface, senator® magic flow G2 refill (1.0 mm), writing length up to 5,000 m, ink colour: blue or black

SERVICES

Mix & Match: from 10,000 pieces, see page 8

PMS Service: from 10,000 pieces, see page 9

BRANDING / AREA

Clip	1	1c - 5c Print CMYK Print	35 x 7 mm
Upper	2	1c - 5c Print	30 x 3 mm
Barrel	3	1c - 5c Print	30 x 15 mm
	4	1c - 5c Print	40 x 12 mm
	5	CMYK Print	60 x 7 mm
	6	1c - 5c Print CMYK Print on white barrel	45 x 34 mm (from 1,000 pieces)

BRIDGE POLISHED MT

Image scale 1:1

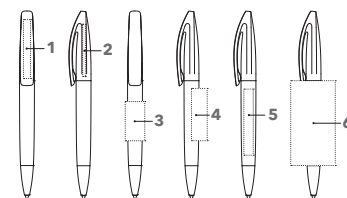

ART. NO. 3252

Twist ball pen

Glossy opaque body and clip surface, glossy metal tip, senator® magic flow G2 refill (1.0 mm), writing length up to 5,000 m, ink colour: blue or black

SERVICES

Mix & Match: from 10,000 pieces, see page 8

PMS Service: from 10,000 pieces, see page 9

BRANDING / AREA

Clip	1	1c - 5c Print CMYK Print	35 x 7 mm
Upper	2	1c - 5c Print	30 x 3 mm
Barrel	3	1c - 5c Print	30 x 15 mm
	4	1c - 5c Print	40 x 12 mm
	5	CMYK Print	60 x 7 mm
	6	1c - 5c Print CMYK Print on white barrel	45 x 34 mm (from 1,000 pieces)

BRIDGE CLEAR

1c Print



Image scale 1:1

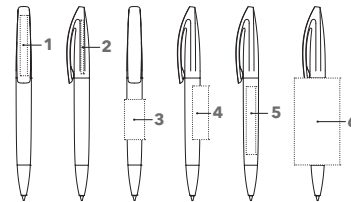
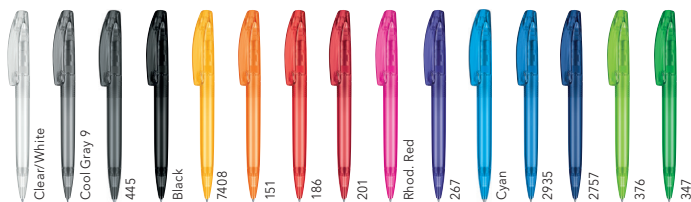

ART. NO. 3251

Twist ball pen

Glossy transparent body and clip surface, senator® magic flow G2 refill (1.0 mm), writing length up to 5,000 m, ink colour: blue or black

SERVICES

Mix & Match: from 10,000 pieces, see page 8

PMS Service: from 10,000 pieces, see page 9

BRANDING / AREA

Clip	1	1c - 5c Print CMYK Print	35 x 7 mm
Upper	2	1c - 5c Print	30 x 3 mm
Barrel	3	1c - 5c Print	30 x 15 mm
	4	1c - 5c Print	40 x 12 mm
	5	CMYK Print	60 x 7 mm
	6	1c - 5c Print	45 x 34 mm (from 1,000 pieces)

BRIDGE CLEAR MT

3c Print



Image scale 1:1

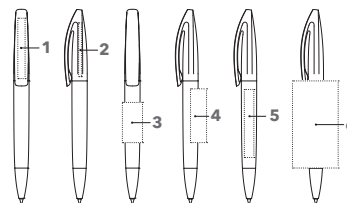

ART. NO. 3253

Twist ball pen

Glossy transparent body and clip surface, glossy metal tip, senator® magic flow G2 refill (1.0 mm), writing length up to 5,000 m, ink colour: blue or black

SERVICES

Mix & Match: from 10,000 pieces, see page 8

PMS Service: from 10,000 pieces, see page 9

BRANDING / AREA

Clip	1	1c - 5c Print CMYK Print	35 x 7 mm
Upper	2	1c - 5c Print	30 x 3 mm
Barrel	3	1c - 5c Print	30 x 15 mm
	4	1c - 5c Print	40 x 12 mm
	5	CMYK Print	60 x 7 mm
	6	1c - 5c Print	45 x 34 mm (from 1,000 pieces)

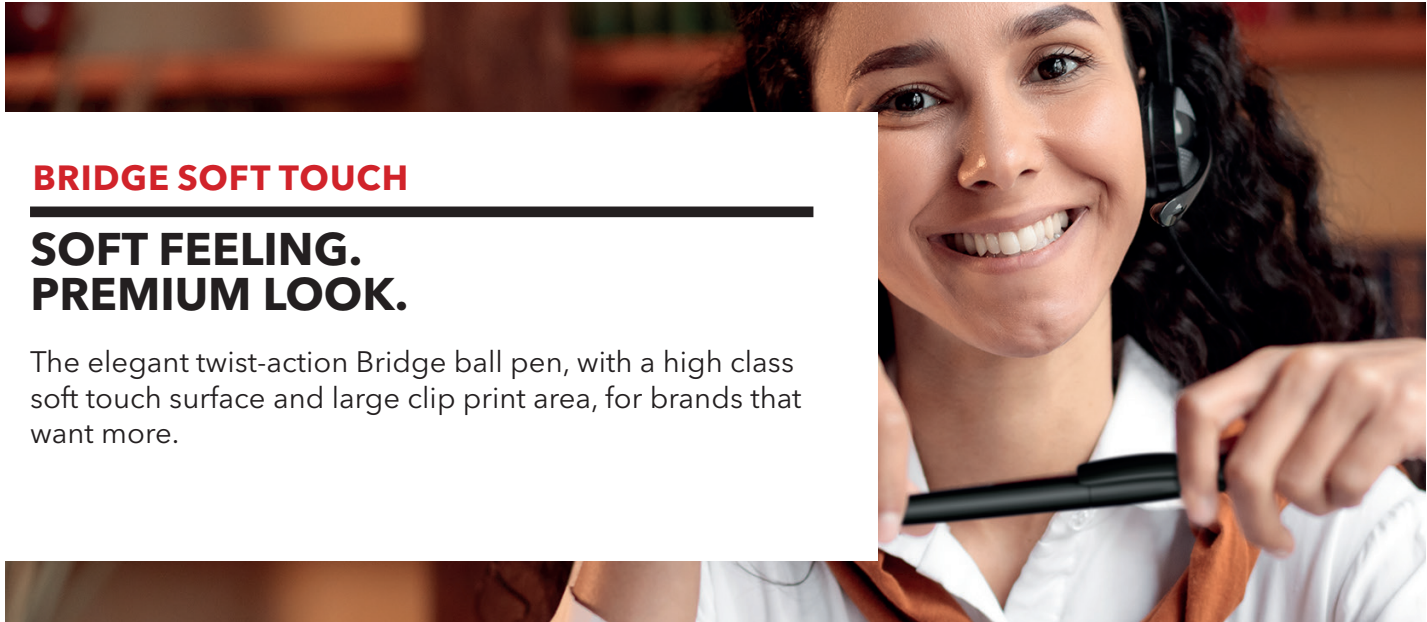

BRIDGE SOFT TOUCH

SOFT FEELING. PREMIUM LOOK.

The elegant twist-action Bridge ball pen, with a high class soft touch surface and large clip print area, for brands that want more.

BRIDGE SOFT TOUCH

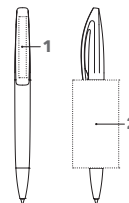

ART. NO. 3257

Twist ball pen

Velvety matt surface,
senator® magic flow G2 refill (1.0 mm),
writing length up to 5,000 m,
ink colour: blue or black

SERVICES

PMS Service: from 10,000 pieces, see page 9

BRANDING / AREA

Clip	1	1c - 5c Print	35 x 7 mm
Barrel	2	1c - 5c Print	45 x 34 mm (from 1,000 pieces)

HEADLINER CLEAR BASIC

Image scale 1:1

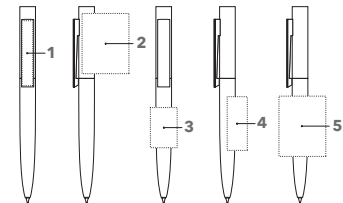
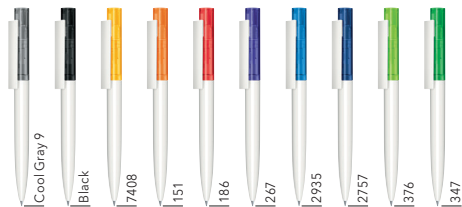

ART. NO. 3281

Twist ball pen

Polished opaque barrel surface mixed with glossy transparent upper surface, polished white clip, senator® magic flow G2 refill (1.0 mm), writing length up to 5,000 m, ink colour: blue or black

SERVICES

PMS Service: from 10,000 pieces, see page 9

BRANDING / AREA

Clip	1	1c - 5c Print CMYK Print	40 x 6 mm
Upper	2	1c - 5c Print	45 x 35 mm (from 1,000 pieces)
Barrel	3	1c - 5c Print	30 x 20 mm
	4	1c - 5c Print	40 x 15 mm
	5	1c - 5c Print CMYK Print	45 x 34 mm (from 1,000 pieces)

HEADLINER POLISHED BASIC

Image scale 1:1

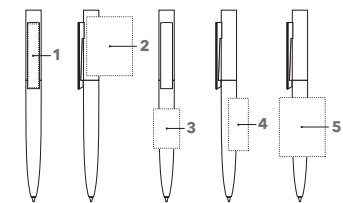
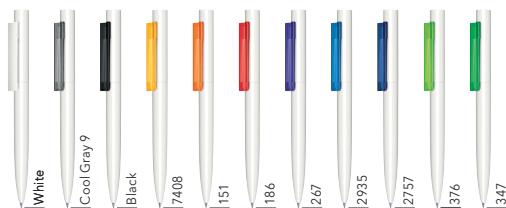

ART. NO. 3280

Twist ball pen

Polished opaque barrel surface, polished white or transparent coloured clip, senator® magic flow G2 refill (1.0 mm), writing length up to 5,000 m, ink colour: blue or black

SERVICES

PMS Service: from 10,000 pieces, see page 9

BRANDING / AREA

Clip	1	1c - 5c Print CMYK Print	40 x 6 mm
Upper	2	1c - 5c Print CMYK Print	45 x 35 mm (from 1,000 pieces)
Barrel	3	1c - 5c Print	30 x 20 mm
	4	1c - 5c Print	40 x 15 mm
	5	1c - 5c Print CMYK Print	45 x 34 mm (from 1,000 pieces)

HEADLINER SOFT TOUCH

ELEGANT DESIGN. PURE CHARACTER.

Elegant, linear design meets extraordinary advertising space for maximum promotional success. Convincing in look and feel. A real delight in the hand.



PENS

senator®
Made in Germany, Since 1920.

HEADLINER SOFT TOUCH

Image scale 1:1

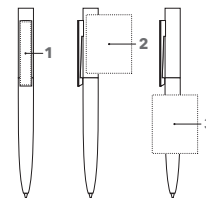
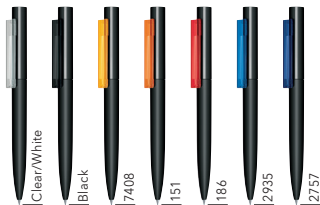

ART. NO. 3285

Twist ball pen

Polished upper, barrel with velvety surface, clear clip, senator® magic flow G2 refill (1.0 mm), writing length up to 5,000 m, ink colour: blue or black

SERVICES

PMS Service: from 10,000 pieces, see page 9

BRANDING / AREA

Clip	1	1c - 5c Print CMYK Print	40 x 6 mm
Upper	2	1c - 5c Print	45 x 35 mm (from 1,000 pieces)
Barrel	3	1c - 5c Print	45 x 34,5 mm (from 1,000 pieces)

POINT POLISHED

Image scale 1:1

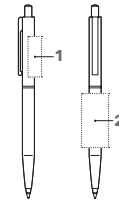

ART. NO. 3217

Push ball pen

Glossy opaque body surface, metal fittings, push-button with plastic inlay matching the barrel colour, senator® magic flow X20 refill (1.0 mm), writing length up to 2,000 m, ink colour: blue or black

SERVICES

PMS Service: from 10,000 pieces, see page 9

BRANDING / AREA

Upper	1	1c - 5c Print	30 x 10 mm
Barrel	2	1c - 5c Print	40 x 20 mm

POINT METAL

Image scale 1:1



NEW

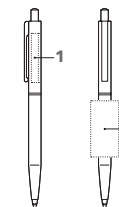
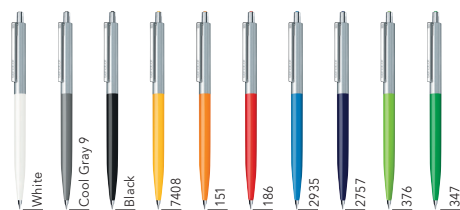

ART. NO. 3317

Push ball pen

Polished opaque body surface, metal upper part, metal fittings, push-button with plastic inlay, senator® magic flow G2 refill (1.0 mm), writing length up to 5,000 m, ink colour: blue

SERVICES

PMS Service: from 10,000 pieces, see page 9

BRANDING / AREA

Upper	1	Engraving	35 x 5 mm
Barrel	2	1c - 5c Print	40 x 20 mm

NEW SPRING POLISHED MC

Image scale 1:1



reddot design award

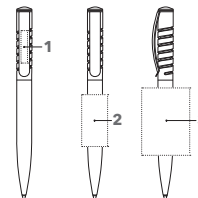

ART. NO. 2310

Push ball pen

Glossy opaque body surface, metallised inner push-button, metal clip, senator® magic flow G2 refill (1.0 mm), writing length up to 5,000 m, ink colour: blue or black

SERVICES

PMS Service: from 10,000 pieces, see page 9

BRANDING / AREA

Clip	1 Engraving	30 x 6 mm
Barrel	2 1c - 5c Print	40 x 20 mm
	3 CMYK Print on white barrel	51 x 37 mm (from 1,000 pieces)

NEW SPRING CLEAR MC

Image scale 1:1



reddot design award

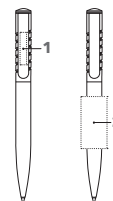

ART. NO. 2410

Push ball pen

Glossy opaque body surface, metallised inner push-button, metal clip, senator® magic flow G2 refill (1.0 mm), writing length up to 5,000 m, ink colour: blue or black

SERVICES

PMS Service: from 10,000 pieces, see page 9

BRANDING / AREA

Clip	1 Engraving	30 x 6 mm
Barrel	2 1c - 5c Print	40 x 20 mm

SIGNER LINER BALL PEN

Image scale 1:1

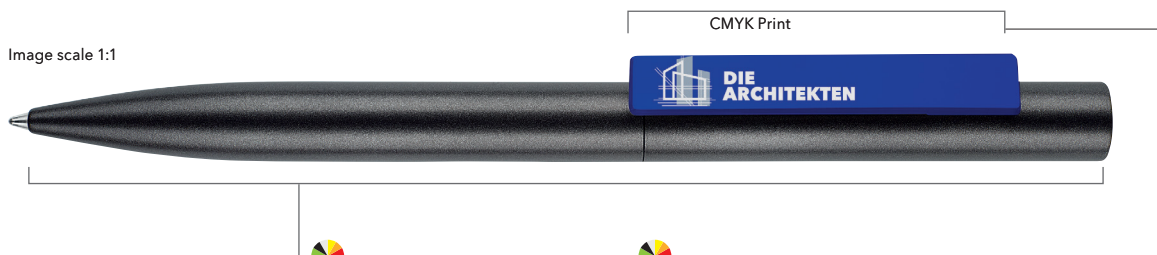

Corresponding cases

- ET 154
- ET 157
- ET 160
- ET 169
- ET 171
- ET 190

see pages 62 - 64



reddot award

Barrel
Metal



Clip
Clear

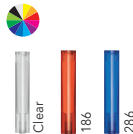

Polished

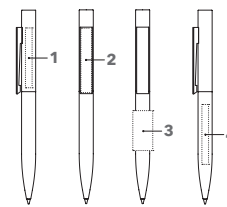

ART. NO. 2709

Twist ball pen

Barrel: Stainless steel, sandblasted or lacquered
Clip: Plastic; clear or polished
senator® magic flow G2 refill (1.0 mm),
writing length up to 8,500 m,
ink colour: blue

BRANDING / AREA

Upper	1	1c Print Engraving	35 x 5 mm
Clip	2	1c - 5c Print CMYK Print	47 x 7 mm
Barrel	3	1c Print	30 x 15 mm
	4	Engraving	40 x 5 mm

POLAR

Image scale 1:1



Corresponding cases

- ET 154
- ET 157
- ET 160
- ET 169
- ET 171
- ET 190

see pages 62 - 64

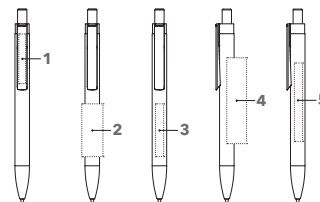

ART. NO. 3261

Push ball pen

Barrel: Metal, varnished
Fittings: Metal, glossy chrome
senator® magic flow G2 refill (1.0 mm),
writing length up to 5,000 m,
ink colour: blue or black

SERVICES

PMS Service:

(Clip holder):
from 10,000 pieces, see page 9

BRANDING / AREA

Clip	1	Engraving	45 x 6 mm
Barrel	2	1c - 5c Print	40 x 16 mm
	3	Engraving	45 x 5 mm
	4	1c - 5c Print	55 x 11 mm
	5	Engraving	60 x 5 mm



ROU BILL

METAL PENS

Rou bill writing instruments are characterised by high-quality materials, precision workmanship, and first-class designs. Sustainably branded in Germany.



METAL PENS

rou bill.
Metal Pens. Branded for you.

rou bill.
Metal Pens. Branded for you.

ARVENT GLOSSY BALL PEN

Image scale 1:1



Corresponding cases

- ET 169
- ET 171
- ET 160
- ET 154
- ET 190

see pages 62 - 64

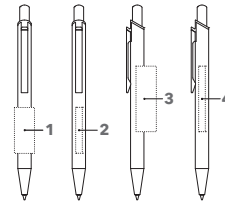

ART. NO. 3360

Push ball pen

Barrel: Metal, glossy lacquered
 Fittings: Metal, glossy chrome
 senator® magic flow metal refill G2 (1.0 mm),
 writing length up to 5,000 m,
 ink colour: blue

BRANDING / AREA

Barrel		
1	1c - 5c Print	35 x 15 mm
2	Engraving	35 x 5 mm
3	1c - 5c Print	50 x 11 mm
4	Engraving	50 x 5 mm

ARVENT SOFT TOUCH BALL PEN

Image scale 1:1

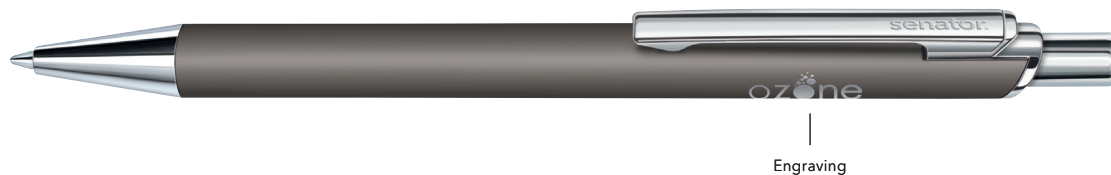

Corresponding cases

- ET 169
- ET 171
- ET 160
- ET 154
- ET 190

see pages 62 - 64

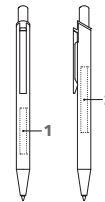

ART. NO. 3365

Push ball pen

Barrel: Metal, soft lacquer
 Fittings: Metal, glossy chrome
 senator® magic flow refill, G2 (1.0 mm),
 writing length up to 5,000 m,
 ink colour: blue

BRANDING / AREA

Barrel		
1	Engraving	35 x 5 mm
2	Engraving	50 x 5 mm

PHENIX

SYMPATHETIC CHARACTER. BRILLIANT PERFORMANCE.

The metal twist ball pen in a high-quality piano lacquer look exudes an incomparable charm and convinces with its shiny personality.



PHENIX BALL PEN

Image scale 1:1

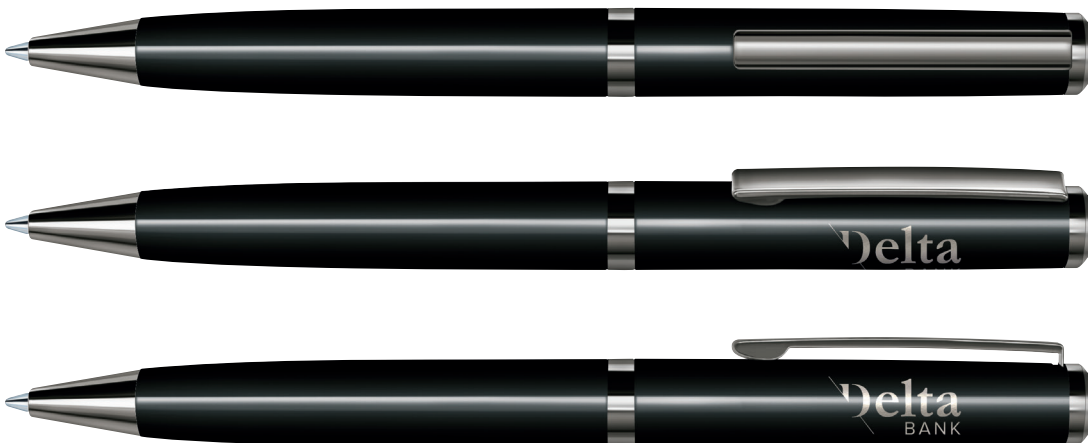

Engraving



METAL PENS

rou bill®
Metal Pens. Blended for you.



Corresponding cases

ET 150
ET 154
ET 156
ET 157
ET 160
ET 169
ET 190

see pages 62 - 64

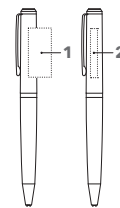

ART. NO. 3380

Twist ball pen

Barrel: Metal, glossy lacquered
Fittings: Metal, gun metal
senator® magic flow metal refill G2 (1.0 mm),
writing length up to 8,500 m,
ink colour: blue

BRANDING / AREA

Cap	1 1c Print	30 x 12 mm
	2 Engraving	35 x 5 mm

ATTRACT STYLUS BALL PEN / TOUCH PAD PEN

Image scale 1:1

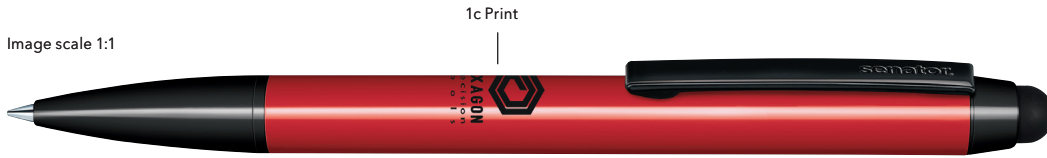

Corresponding cases

- ET 154
- ET 160
- ET 169
- ET 171
- ET 190

see pages 62 - 64

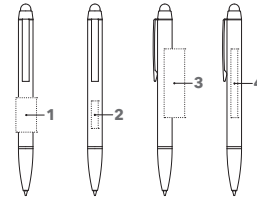

ART. NO. 3330

Twist ball pen with Touch Pad function

Barrel: Metal, glossy lacquered
Fittings: Metal, black lacquered
senator® magic flow metal refill G2 (1.0 mm),
writing length up to 8,500 m,
ink colour: blue

BRANDING / AREA

Barrel		
1	1c Print	25 x 15 mm
2	Engraving	20 x 5 mm
3	1c Print	50 x 15 mm
4	Engraving	35 x 5 mm

ATTRACT SOFT TOUCH BALL PEN / TOUCH PAD PEN

Image scale 1:1



Engraving



Corresponding cases

- ET 154
- ET 160
- ET 169
- ET 171
- ET 190

see pages 62 - 64

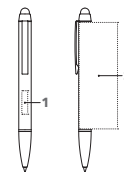

ART. NO. 3335

Twist ball pen with Touch Pad function

Barrel: Metal, soft lacquered
Fittings: Metal, black lacquered
senator® magic flow metal refill G2 (1.0 mm),
writing length up to 8,500 m,
ink colour: blue

BRANDING / AREA

Barrel		
1	Engraving	20 x 5 mm
2	Engraving	50 x 5 mm

GALANT BALL PEN

Image scale 1:1



Corresponding cases

- ET 154
- ET 160
- ET 169
- ET 171
- ET 190

see pages 62 - 64

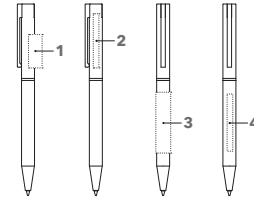

ART. NO. 3370

Twist ball pen

Barrel: Metal, glossy lacquered
 Fittings: Metal, glossy chrome
 senator® magic flow metal refill G2 (1.0 mm),
 writing length up to 8,500 m,
 ink colour: blue

BRANDING / AREA

Upper	1	1c Print	25 x 10 mm
	2	Engraving	40 x 5 mm
Barrel	3	1c Print	35 x 10 mm
	4	Engraving	50 x 5 mm

METAL PENS

rou bill.
Metal Pens. Branded for you.

ARCTIC BALL PEN

Image scale 1:1



Corresponding cases

- ET 150
- ET 154
- ET 156
- ET 160
- ET 190

see pages 62 - 64



With the refill retracted,
 the branding will appear in
 line with the clip, with the
 stitching on the reverse.

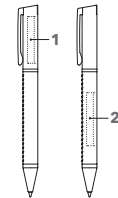

ART. NO. 3390

Twist ball pen

Barrel: Metal, synthetic leather
 Fittings: Metal, glossy gun metal
 senator® magic flow metal refill G2 (1.0 mm),
 writing length up to 8,500 m,
 ink colour: blue

BRANDING / AREA

Cap	1	Engraving	35 x 5 mm
Barrel	2	Engraving	40 x 5 mm

STAR TEC STEEL BALL PEN

Image scale 1:1



1c Print



Corresponding cases

- ET 150
- ET 154
- ET 156
- ET 160
- ET 169
- ET 190

see pages 62 - 64

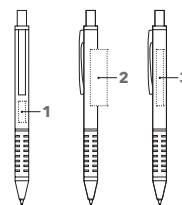

ART. NO. 2040

Push ball pen

Barrel: Metal, brushed
 Fittings: Metal, glossy chrome
 Soft grip zone: black
 senator® magic flow metal refill G2 (1.0 mm),
 writing length up to 8,500 m,
 ink colour: blue

BRANDING / AREA

Barrel		
1	Engraving	15 x 5 mm
2	1c - 5c Print	40 x 12 mm
3	Engraving	40 x 5 mm

STAR TEC ALU BALL PEN

Image scale 1:1



1c Print



Corresponding cases

- ET 150
- ET 154
- ET 156
- ET 160
- ET 169
- ET 190

see pages 62 - 64

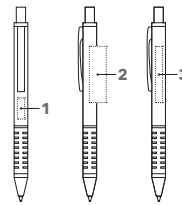

ART. NO. 2511

Push ball pen

Barrel: Metal, lacquered
 Fittings: Metal, glossy chrome
 Soft grip zone: black
 senator® magic flow metal refill G2 (1.0 mm),
 writing length up to 8,500 m,
 ink colour: blue

BRANDING / AREA

Barrel		
1	Engraving	15 x 5 mm
2	1c - 5c Print	40 x 12 mm
3	Engraving	40 x 5 mm

NAUTIC BALL PEN

Image scale 1:1



Corresponding cases

- ET 150
- ET 154
- ET 156
- ET 160
- ET 169
- ET 171
- ET 190

see pages 62 - 64

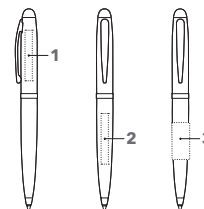

ART. NO. 2215

Twist ball pen

Barrel and fittings: Metal, glossy chrome
 Cap: Metal, soft lacquer
 senator® magic flow metal refill G2 (1.0 mm),
 writing length up to 8,500 m,
 ink colour: blue

BRANDING / AREA

Cap	1	Engraving	35 x 5 mm
Barrel	2	Engraving	35 x 5 mm
	3	1c Print	25 x 12 mm

METAL PENS

rou bill.
Metal Pens. Branded for you.

NAUTIC ROLLERBALL

Image scale 1:1



Corresponding cases

- ET 150
- ET 154
- ET 156
- ET 160
- ET 169
- ET 171
- ET 190

see pages 62 - 64



6297

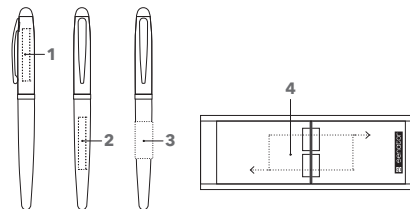

ART. NO. 1092 / 6297

Rollerball 1092

Barrel and fittings: Metal, glossy chrome
 Cap and grip zone: Metal, soft lacquer
 Metal safety rollerball refill
 Ink colour: blue

Set 6297

Touch Pad Pen 2754 + rollerball 1092
 in case ET 171

BRANDING / AREA

Cap	1	Engraving	35 x 5 mm
Barrel	2	Engraving	35 x 5 mm
	3	1c Print	25 x 12 mm
Case	4	1c Print	60 x 25 mm

NAUTIC BALL PEN / TOUCH PAD PEN

Image scale 1:1



Corresponding cases

- ET 150
- ET 154
- ET 156
- ET 160
- ET 169
- ET 171
- ET 190

see pages 62 - 64



6297

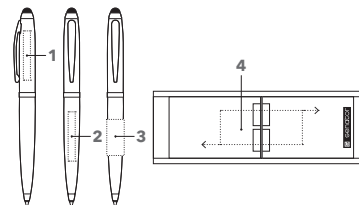

ART. NO. 2754 / 6297

Twist ball pen with touch pad function 2754

Barrel and fittings: Metal, glossy chrome
Cap: Metal, soft lacquer
senator® magic flow metal refill G2 (1.0 mm),
writing length up to 8,500 m,
ink colour: blue

Set 6297

Touch Pad Pen 2754 + rollerball 1092
in case ET 171

BRANDING / AREA

Cap	1 Engraving	35 x 5 mm
Barrel	2 1c Print	25 x 12 mm
	3 Engraving	35 x 5 mm
Case	4 1c Print	60 x 25 mm

NAUTIC BLACK BALL PEN / TOUCH PAD PEN

Image scale 1:1



Engraving



Corresponding cases:

- ET 150
- ET 154
- ET 156
- ET 160
- ET 169
- ET 171
- ET 190

see pages 62 - 64

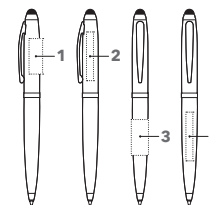

ART. NO. 3340

Twist ball pen with touch pad function

Barrel : Metal, glossy lacquer
Fittings: Metal, gun metal
senator® magic flow metal refill G2 (1.0 mm),
writing length up to 8,500 m,
ink colour: blue

BRANDING / AREA

Cap	1 1c Print	25 x 10 mm
	2 Engraving	35 x 5 mm
Barrel	3 1c Print	25 x 12 mm
	4 Engraving	35 x 5 mm

IMAGE LINE

MAKES YOUR IMAGE UNMISTAKABLE.

Clear lines, perfect style with a distinctive surface design. The Image Line presents itself in a perfect manner.



IMAGE BLACK LINE BALL PEN

Image scale 1:1



METAL PENS

rou bill.
Metal Pens. Branded for you.



Black

Corresponding cases

ET 150
ET 154
ET 156
ET 160
ET 169
ET 171
ET 190

see pages 62 - 64



PROMOTIONAL GIFT
AWARD

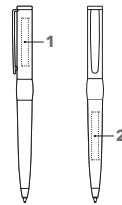

ART. NO. 2636

Twist ball pen

Barrel: Metal, soft varnish
Fittings: Metal, gun metal
senator® magic flow metal refill G2 (1.0 mm),
writing length up to 8,500 m,
ink colour: blue

BRANDING / AREA

Cap	1	Engraving	35 x 5 mm
Barrel	2	Engraving	35 x 5 mm

IMAGE BLACK LINE ROLLERBALL



Image scale 1:1

Engraving



Corresponding cases
ET 150
ET 154
ET 156
ET 160
ET 169
ET 171
ET 190
see pages 62 - 64



6206

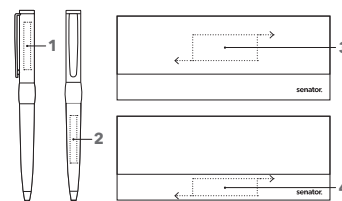

ART. NO. 1119 / 6179 / 6206

Rollerball 1119

Barrel: Metal, soft varnish,
fittings: Metal, gun metal
Metal safety rollerball refill, ink colour: blue

Set 6206

Twist ball pen 2636 + rollerball 1119
in black case ET 156

BRANDING / AREA

Cap	1	Engraving	35 x 5 mm
Barrel	2	Engraving	35 x 5 mm
Case	3	1c Print	50 x 20 mm
	4	1c Print	50 x 15 mm

IMAGE BLACK LINE FOUNTAIN PEN



Image scale 1:1

Engraving



Corresponding cases
ET 150
ET 154
ET 156
ET 160
ET 169
ET 171
ET 190
see pages 62 - 64



6205

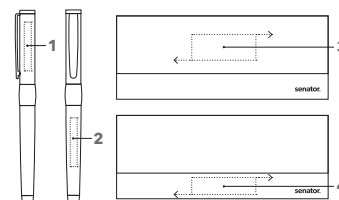

ART. NO. 0104 / 6205

Fountain pen

Barrel: Metal, soft varnish,
fittings: Metal gun metal
Iridium-tipped stainless steel nib, M, standard ink
cartridge, ink colour: blue

Set 6205

Twist ball pen 2636 + fountain pen 0104
in black case ET 156

BRANDING / AREA

Cap	1	Engraving	35 x 5 mm
Barrel	2	Engraving	35 x 5 mm
Case	3	1c Print	50 x 20 mm
	4	1c Print	50 x 15 mm

IMAGE WHITE LINE BALL PEN

Image scale 1:1



Corresponding cases

- ET 150
- ET 154
- ET 156
- ET 160
- ET 169
- ET 171
- ET 190

see pages 62 - 64



6267

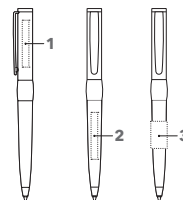

ART. NO. 2786 / 6267

Twist ball pen 2786

Barrel: metal, glossy lacquered
Fittings: Glossy chrome
senator® magic flow metal refill G2 (1.0 mm),
writing length up to 8,500 m,
ink colour: blue

Set 6267

Twist ball pen 2786 + rollerball 1146
in white case ET 156

BRANDING / AREA

Cap	1 Engraving 1c Print	35 x 5 mm
Barrel	2 Engraving 3 1c Print	35 x 5 mm 20 x 12 mm

METAL PENS

rou bill.
Metal Pens. Branded for you.

IMAGE WHITE LINE ROLLERBALL

Image scale 1:1



Corresponding cases

- ET 150
- ET 154
- ET 156
- ET 160
- ET 169
- ET 171
- ET 190

see pages 62 - 64



6267

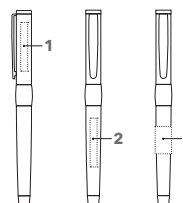

ART. NO. 1146 / 6267

Rollerball 1146

Barrel: metal, glossy lacquered
Fittings: Glossy chrome
Metal safety rollerball refill
Ink colour: blue

Set 6267

Twist ball pen 2786 + Rollerball 1146
in white case ET 156

BRANDING / AREA

Cap	1 Engraving 1c Print	35 x 5 mm
Barrel	2 Engraving 3 1c Print	35 x 5 mm 20 x 12 mm

IMAGE CHROME BALL PEN

Image scale 1:1



Corresponding cases

- ET 150
- ET 154
- ET 156
- ET 160
- ET 169
- ET 171
- ET 181
- ET 190

see pages 62 - 64

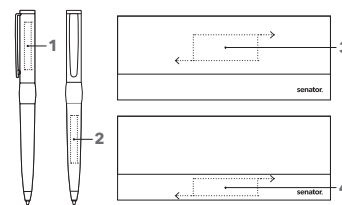

ART. NO. 2158 / 6238

Twist ball pen 2158

Barrel: Metal, soft varnish,
fittings: Metal, matt chrome,
senator® magic flow metal refill G2 (1.0 mm),
writing length up to 8,500 m,
ink colour: blue

Set 6238

Twist ball pen 2158 + rollerball 1036 in black case
ET 156

BRANDING / AREA

Cap	1 Engraving	35 x 5 mm
Barrel	2 Engraving	35 x 5 mm
Case	3 1c Print	50 x 20 mm
	4 1c Print	50 x 15 mm

IMAGE CHROME ROLLERBALL

Image scale 1:1



Corresponding cases

- ET 150
- ET 154
- ET 156
- ET 160
- ET 169
- ET 171
- ET 181
- ET 190

see pages 62 - 64

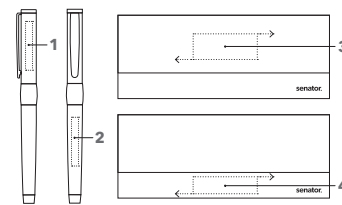

ART. NO. 1036 / 6238

Rollerball 1036

Barrel: Metal, soft varnish,
fittings: Metal, matt
chrome, metal safety rollerball refill
Ink colour: blue

Set 6238

Twist ball pen 2158 + rollerball 1036 in black case
ET 156

BRANDING / AREA

Cap	1 Engraving	35 x 5 mm
Barrel	2 Engraving	35 x 5 mm
Case	3 1c Print	50 x 20 mm
	4 1c Print	50 x 15 mm

CARBON

SPORTY, ELEGANT AND SOPHISTICATED.

Sporty writing instrument in an remarkable mix of materials. Cool carbon combines with matt-chrome fittings to create a modern statement accessory.

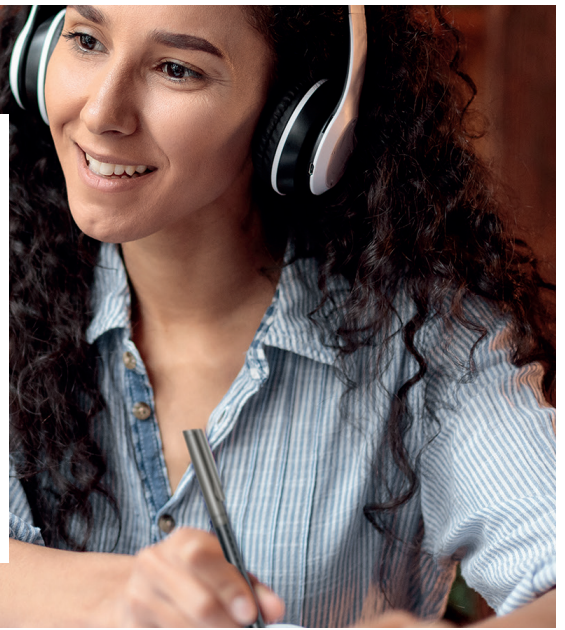

CARBON BLACK BALL PEN

Image scale 1:1



Engraving

PRINTED
IN
GERMANY

AS
LONG AS
STOCKS
LAST

AS
LONG AS
STOCKS
LAST

METAL PENS

rou bill.
Metal Pens. Branded for you.



Carbon

Corresponding cases

ET 150
ET 154
ET 160,
ET 169
ET 171
ET 181
ET 190

see pages 62 - 64

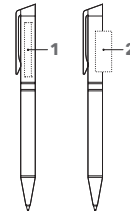

ART. NO. 3350

Twist ball pen

Barrel: Metal in combination with light carbon
Fittings: Metal gun metal
senator® magic flow metal refill G2 (1.0 mm),
writing length up to 8,500 m,
ink colour: blue

This item will be discontinued and is still available as long as stocks last.

BRANDING / AREA

Cap		
1	Engraving	40 x 5 mm
2	1c Print	30 x 12 mm

CARBON LINE

SPORTY WRITING INSTRUMENT IN A UNIQUE MIX OF MATERIALS.

High-quality carbon in combination with matt chrome-plated fittings combine to create an expressive design with a slim silhouette.



CARBON LINE BALL PEN

Image scale 1:1

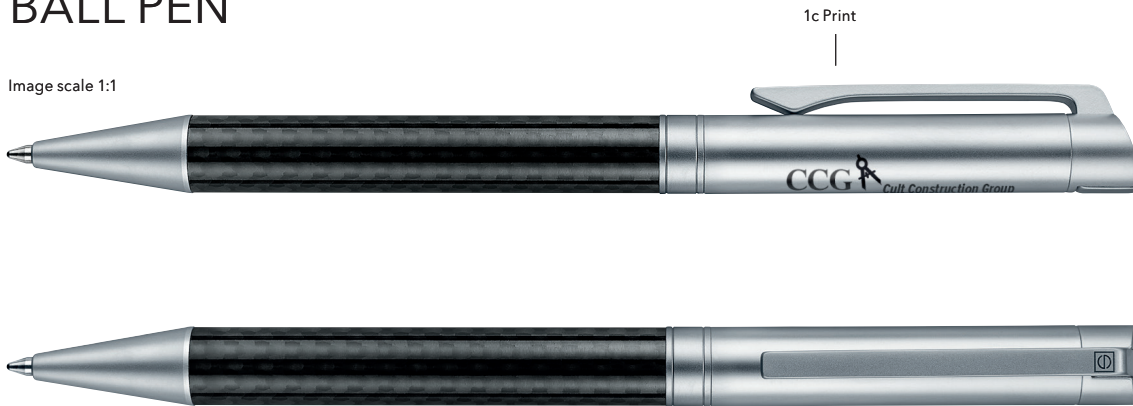

Corresponding cases

- ET 150
- ET 154
- ET 156
- ET 160
- ET 169
- ET 171
- ET 190

see pages 62 - 64



6239
6240

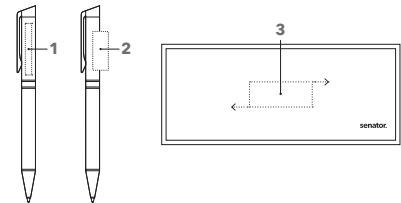

ART. NO. 2159 / 6239 / 6240

Twist ball pen 2159

Metal in combination with light carbon
Cap, tip, fittings: Metal, matt chrome, senator®
magic flow metal refill G2 (1.0 mm), writing length
up to 8,500 m, ink colour: blue

Set 6239

Twist ball pen 2159 + fountain pen 0076 in black
case ET 160

Set 6240

Twist ball pen 2159 + rollerball 1037 in black case
ET 160

BRANDING / AREA

Part	Branding	Area
Cap	1 Engraving	40 x 5 mm
	2 1c Print	30 x 12 mm
Case	3 1c Print	50 x 20 mm

CARBON LINE ROLLERBALL

Image scale 1:1



Corresponding cases

- ET 150
- ET 154
- ET 156
- ET 160
- ET 169
- ET 171
- ET 190

see pages 62 - 64



6240

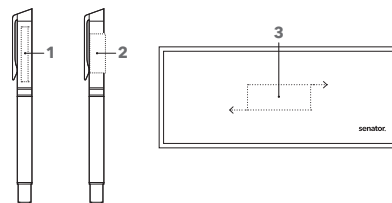

ART. NO. 1037 / 6240

Rollerball 1037

Metal in combination with light carbon
Cap, tip, fittings: Metal, matt chrome
Metal safety rollerball refill
Ink colour: blue

Set 6240

Twist ball pen 2159 + Rollerball 1037
in black case ET 160

BRANDING / AREA

Cap	1 Engraving	40 x 5 mm
	2 1c Print	30 x 12 mm
Case	3 1c Print	50 x 20 mm

METAL PENS

rou bill.
Metal Pens. Branded for you.

CARBON LINE FOUNTAIN PEN

Image scale 1:1

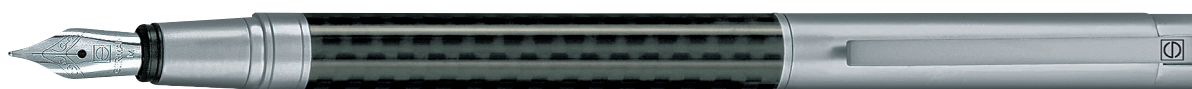

Corresponding cases

- ET 150
- ET 154
- ET 156
- ET 160
- ET 169
- ET 171
- ET 190

see pages 62 - 64



6239

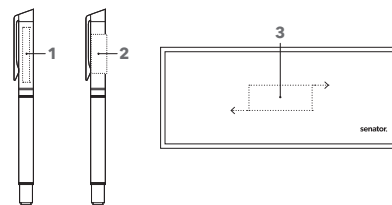

ART. NO. 0076 / 6239

Fountain pen 0076

Metal in combination with light carbon
Cap, tip, fittings: Metal, matt chrome
Iridium-tipped stainless steel nib, M
Standard ink cartridge
Ink colour: blue

Set 6239

Twist ball pen 2159 + fountain pen 0076 in black
case ET 160

BRANDING / AREA

Cap	1 Engraving	40 x 5 mm
	2 1c Print	30 x 12 mm
Case	3 1c Print	50 x 20 mm

TIZIO

NATURALNESS WITH AN INDIVIDUAL TOUCH.

Natural writing with a special touch. For all those who appreciate the individual value of a natural material and write their messages with select care.



TIZIO BALL PEN

Image scale 1:1



Engraving



Corresponding cases

- ET 150
- ET 160
- ET 169
- ET 171
- ET 181
- ET 190

see pages 62 - 64

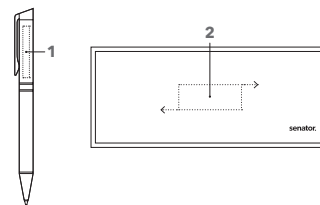

ART. NO. 2400 / 6252 / 6253

Twist ball pen 2400

Barrel: Metal in combination with nutwood
Cap, tip, fittings: Metal, glossy chrome
senator® magic flow metal refill G2 (1.0 mm),
writing length up to 8,500 m, ink colour: blue

Set 6252

Twist ball pen 2400 + fountain pen 0240 in black case ET 160

Set 6253

Twist ball pen 2400 + rollerball 1240 in black case ET 160

BRANDING / AREA

Cap	1	Engraving	40 x 5 mm
Case	2	1c Print	50 x 20 mm

TIZIO ROLLERBALL



Image scale 1:1



Corresponding cases

- ET 150
- ET 156
- ET 160
- ET 169
- ET 171
- ET 190

see pages 62 - 64



6253

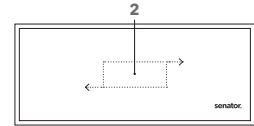
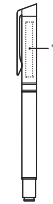

ART. NO. 1240 / 6253

Rollerball 1240

Barrel: Metal in combination with nutwood
Cap, tip, fittings: Metal, glossy chrome
Metal safety rollerball refill
Ink colour: blue

Set 6253

Twist ball pen 2400 + rollerball 1240 in black case
ET 160

BRANDING / AREA

Cap	1	Engraving	40 x 5 mm
Case	2	1c Print	50 x 20 mm

METAL PENS

rou bill.
Metal Pens. Branded for you.

TIZIO FOUNTAIN PEN



Image scale 1:1



Corresponding cases

- ET 150
- ET 156
- ET 160
- ET 169
- ET 171
- ET 190

see pages 62 - 64



6252

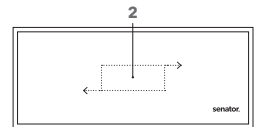

ART. NO. 0240 / 6252

Fountain pen 0240

Barrel: Metal in combination with nutwood
Cap, fittings: Metal, glossy chrome
Iridium-tipped stainless steel nib, M
Standard ink cartridge
Ink colour: blue

Set 6252

Twist ball pen 2400 + fountain pen 0240 in black case ET 160

BRANDING / AREA

Cap	1	Engraving	40 x 5 mm
Case	2	1c Print	50 x 20 mm

CASES



P1ET157



P1ET173

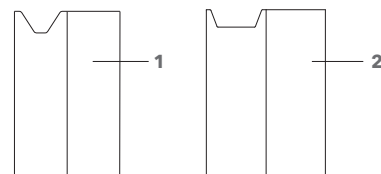

ART. NO. P1ET157

Cardboard pouch for 1 - 2 writing instruments

Recycled cardboard, matt white, front and back to be customised over the full surface area, **Dimensions:** 155 x 48 x 2 cm

BRANDING / AREA

Front + Reverse 1 CMYK Print ca. 155 x 96 mm

ART. NO. P1ET173

Cardboard pouch for 3 writing instruments

Recycled cardboard, matt white, front and back to be customised over the full surface area, **Dimensions:** 155 x 54 x 2 cm

BRANDING / AREA

Front + Reverse 2 CMYK Print ca. 155 x 108 mm



ART. NO. ET 157

For 1 writing instrument

Carton, matt black. At 5,000 pcs. also available in different colours
Dimensions: 155 x 50 x 2 mm

ART. NO. ET 190

For 1 or 2 writing instruments

Carton, FSC Mix, matt black, with removable cardboard insert
Dimensions: 175 x 62 x 22 mm

CASES



ART. NO. ET 156

Cardboard case for 1 or 2 writing instruments

carded case, black matt or glossy white with magnetic closure and foam inlay
Dimensions: 16.5 x 6.5 x 2.5 cm

BRANDING / AREA

Lid	1	1c Print only on black	50 x 20 mm
	2	1c Print only on black	50 x 15 mm

METAL PENS

rou bill.
Metal Pens. Branded for you.

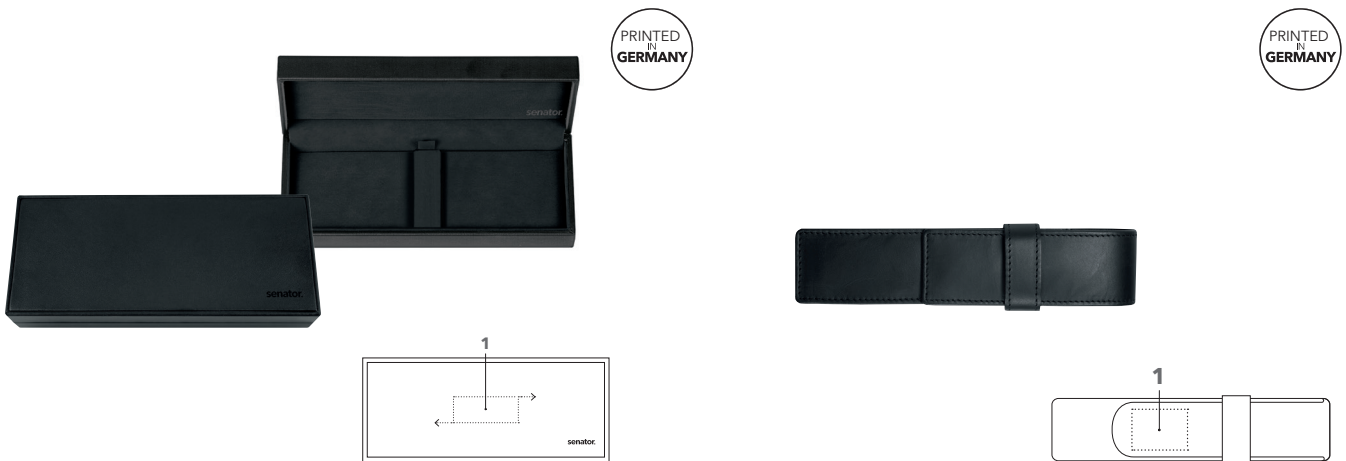

ART. NO. ET 160

For 1 or 2 writing instruments

leather look, black with black velour lining
Dimensions: 19 x 8 x 3.5 cm

BRANDING / AREA

Lid	1	1c Print	50 x 20 mm
------------	----------	----------	------------

ART. NO. ET 150

Leather case for 1 or 2 writing instruments

leather, black
Dimensions: 15 x 3.5 x 1.5 cm

BRANDING / AREA

Flap	1	Embossing	50 x 20 mm
-------------	----------	-----------	------------

CASES

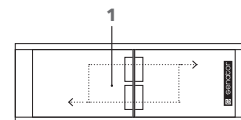

ART. NO. ET 169

Plastic case for 1 writing instrument
Glossy transparent with universal pen holder
Dimensions: 15,5 x 2,5 x 2,5 cm

This item will be discontinued and is still available as long as stocks last.

BRANDING / AREA

Lid	1 1c Print	50 x 20 mm
------------	-------------------	------------

ART. NO. ET 171

Plastic case for 2 writing instruments
Glossy transparent with universal pen holder
Dimensions: 15,5 x 5,5 x 2,5 cm

This item will be discontinued and is still available as long as stocks last.

BRANDING / AREA

Lid	1 1c Print	50 x 20 mm
------------	-------------------	------------

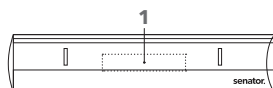

ART. NO. ET 154

Plastic case for 1 writing instrument
black/silver with transparent lid, also available for slim writing instruments
Dimensions: 16 x 3,5 x 2,5 cm

This item will be discontinued and is still available as long as stocks last.

BRANDING / AREA

Lid	1 1c Print	50 x 20 mm
------------	-------------------	------------

ART. NO. SC233

Cardboard box for 50 pens
Alternative packaging for your pens:
Carton: white, with senator® logo
Dimensions: 15,5 x 12 x 7,5 cm

SENATOR

MUGS

Our senator® mugs guarantee a brilliant brand image thanks to their significantly lower CO₂ footprint compared to imported products. Quick and easy turnaround, with up to 5 colours printed in Germany.



MUGS

senator[®]
Made in Germany. Since 1920.

senator[®]
Made in Germany. Since 1920.

AMITY

Image scale 1:2



ART. NO. 0321

Small porcelain mug

With extravagant handle, glossy white, suitable for coffee pod machines

Height: ~ 80 mm
Diameter: ~ 80 mm
Capacity: ~ 0.25 l

SERVICES

Packaging: see page 88

BRANDING / AREA

Outside	1	1c - 5c Print	50 x 55 mm
----------------	----------	---------------	------------

FRIEDA



NEW



ART. NO. K011

Elegant stoneware mug

With stylish curved handle, high gloss white

Height: ~ 100 mm
Diameter: ~ 78 mm
Capacity: ~ 0.25 l

SERVICES

Packaging: see page 88

BRANDING / AREA

Outside	1	1c - 5c Print	158 x 55 mm
----------------	----------	---------------	-------------

CHARISMA

Image scale 1:2



ART. NO. 0915

High porcelain mug

with small handle, high-gloss white

Height: ~ 100 mm

Diameter: ~ 82 mm

Capacity: ~ 0.25 l

SERVICES

Packaging: see page 88

BRANDING / AREA

Outside	1	1c - 5c Print	50 x 35 mm
----------------	----------	---------------	------------

PRIME

Image scale 1:2



ART. NO. 0341

Slim porcelain mug

In classic shape, high-gloss white

Height: ~ 105 mm

Diameter: ~ 73 mm

Capacity: ~ 0.27 l

SERVICES

Packaging: see page 88

BRANDING / AREA

Outside	1	1c - 5c Print	145 x 20 mm
----------------	----------	---------------	-------------

MUGS

senator®
Made in Germany. Since 1920.

ELITE

Image scale 1:2



ART. NO. 0912

Porcelain mug

In elegant design,
high gloss white.

Height: ~ 100 mm

Diameter: ~ 80 mm

Capacity: ~ 0.25 l

SERVICES

Packaging: see page 88

BRANDING / AREA

Outside	1	1c - 5c Print	175 x 35 mm
----------------	----------	---------------	-------------

ELEGANT

Image scale 1:2



ART. NO. 0381

Porcelain mug

Slightly conical shape,
high gloss white.

Height: ~ 92 mm

Diameter: ~ 86 mm

Capacity: ~ 0.3 l

SERVICES

Packaging: see page 88

BRANDING / AREA

Outside	1	1c - 5c Print	190 x 40 mm
----------------	----------	---------------	-------------

MAXI MUG

Image scale 1:2



ART. NO. 0344

Large porcelain mug

In classic design,
high-gloss white

Height: ~ 96 mm
Diameter: ~ 82 mm
Capacity: ~ 0.3 l

SERVICES

Packaging: see page 88

BRANDING / AREA

Outside	1	1c - 5c Print	180 x 70 mm
----------------	----------	---------------	-------------

APPEAL

Image scale 1:2



ART. NO. 0928

Large porcelain mug

In rounded shape,
high-gloss white

Height: ~ 95 mm
Diameter: ~ 100 mm
Capacity: ~ 0.4 l

SERVICES

Packaging: see page 88

BRANDING / AREA

Outside	1	1c - 5c Print	50 x 45 mm
----------------	----------	---------------	------------

FANCY ESPRESSO SET

Image scale 1:2

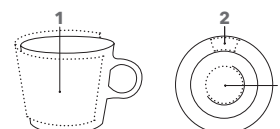

ART. NO. 0964

Espresso Set

Porcelain espresso cup and saucer, glossy white, suitable for coffee pod machines

Height: ~ 67 mm
Diameter: ~ 67 mm
Capacity: ~ 0.08 l
Diameter saucer: ~ 120 mm

BRANDING / AREA

Cup	1	1c - 5c Print	150 x 45 mm
Saucer	2	1c - 5c Print	40 x 15 mm
	3	1c - 5c Print	Ø 45 mm

FANCY COFFEE CUP AND SET

Image scale 1:2

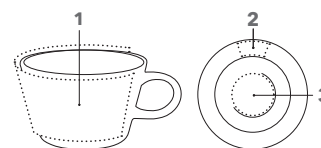

ART. NO. 0965 / 0965-T

Small porcelain cup with saucer 0965

In classic design, high-gloss white, suitable for coffee pod machines

Small porcelain cup 0965-T

in classic design, high-gloss white, suitable for coffee pod machines

Height: ~ 65 mm
Diameter: ~ 90 mm
Capacity: ~ 0.18 l
Diameter saucer: ~ 150 mm

BRANDING / AREA

Cup	1	1c - 5c Print	175 x 50 mm
Saucer	2	1c - 5c Print	40 x 20 mm
	3	1c - 5c Print	Ø 55 mm

FANCY PLATES

Image scale 1:4



ART. NO. 0966 / 0993 / 0994

Plate 0966

Porcelain, glossy white

Diameter: ~210 mm

Dinner plate 0993

Porcelain, glossy white

Diameter: ~270 mm

Soup plate 0994

Porcelain, glossy white

Diameter: ~230 mm

BRANDING / AREA

0966	1	1c - 5c Print	40 x 20 mm
	2	1c - 5c Print	Ø 100 mm
0993	1	1c - 5c Print	100 x 20 mm
	2	1c - 5c Print	Ø 100 mm
0994	1	1c - 5c Print	80 x 20 mm
	2	1c - 5c Print	Ø 100 mm

FANCY BOWL

Image scale 1:2



ART. NO. 0920

Porcelain bowl

Glossy white

Height: ~79 mm

Diameter: ~150 mm

Capacity: ~0.7 l

BRANDING / AREA

Outside	1	1c - 5c Print	457 x 30 mm
----------------	----------	---------------	-------------

MUGS

senator®
Made in Germany. Since 1920.

FANCY START-UP BOX

Image scale 1:3

2c Print



White

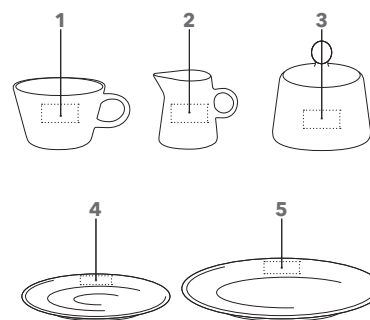

ART. NO. 0951

Porcelain set

74 pieces, white
cups suitable for coffee pod machines:
24 cups and saucers,
24 plates,
1 milk jug,
1 sugar bowl

Height cup: ~ 65 mm
Diameter cup: ~ 90 mm
Capacity cup: ~ 0.18 l
Diameter saucer: ~ 150 mm
Diameter plate: ~ 210 mm
Height milk jug: ~ 78 mm
Height sugar bowl: ~ 58 mm
(mit Deckel ~ 90 mm)

BRANDING / AREA

Cup	1	1c - 5c Print	40 x 20 mm
Milk jug	2	1c - 5c Print	40 x 20 mm
sugar bowl	3	1c - 5c Print	40 x 20 mm
saucer	4	1c - 5c Print	40 x 20 mm
Plate	5	1c - 5c Print	40 x 20 mm

KÖSSINGER

MUGS

A growing range of mugs and cups is now presented under the kössinger brand, featuring a new variety of shapes and colours. Simple, affordable, and quickly branded in Germany.



MUGS

kössinger
Mugs. Branded for you.

kössinger
Mugs. Branded for you.

KING CAN

LOOKS COOL. KEEPS HOT.

King Can "To Go" mugs are the perfect every day companions. These vacuum thermo mugs keep hot drinks hot and cold drinks cold. Useful, long lasting and so popular.



KING CAN

Image scale 1:2



CMYK Print



Engraving

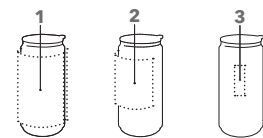

ART. NO. 0755 / 0765

Vakuu-Thermodose

Double-walled 18/8 stainless steel, with black plastic lid

Height: ~ 149 mm

Diameter: ~ 71 mm

Capacity: ~ 0.33 l

SERVICES

Individually packed in cardboard box.

BRANDING / AREA

Outside		
1	1c - 5c Print	210 x 115 mm
2	CMYK Print (White prints will show silver coloured)	150 x 80 mm
3	Engraving	20 x 60 mm

KING CAN MINI

Image scale 1:2



2c Print

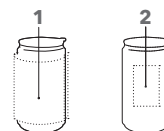

ART. NO. 0785

Vacuum thermo mug

Double-walled 18/8 stainless steel, with black plastic lid

Height: ~ 127 mm

Diameter: ~ 71 mm

Capacity: ~ 0.26 l

SERVICES

Individually packed in cardboard box.

BRANDING / AREA

Outside		
1	1c - 5c Print	210 x 90 mm
2	Engraving	20 x 60 mm

TROPHY

Image scale 1:2



1c Print

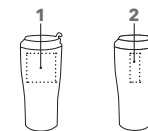

ART. NO. 0750

Large vacuum thermo mug

Double-walled 18/8 stainless steel, with black plastic lid

Height: ~ 175 mm

Diameter: ~ 82 mm

Capacity: ~ 0.4 l

SERVICES

Individually packed in cardboard box.

BRANDING / AREA

Outside		
1	1c - 5c Print	60 x 60 mm
2	Engraving	20 x 60 mm

MUGS

kössinger
Mugs. Branded for you.



OUTDOOR

LONG-LASTING COMPANION IN CHARMING VINTAGE STYLE.

Simply unbeatable in durability and charm. Classic design, unbreakable and weatherproof. A companion for carefree outdoor leisure activities.

OUTDOOR

Image scale 1:2

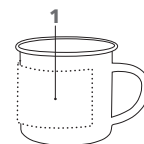

ART. NO. 0372

Metal cup

With enamel coating, high-gloss white

Height: ~81 mm

Diameter: ~87 mm

Capacity: ~0.3 l

SERVICES

Individually packed in cardboard box

BRANDING / AREA

Outside	1	CMYK Print	185 x 60 mm
----------------	----------	------------	-------------

CARINA WHITE

Image scale 1:2

CMYK Print

1c Print

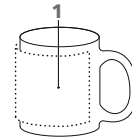

MODELL 0323 / K002

Large stoneware mug

In straight design, high-gloss white.

Height: ~95 mm
Diameter: ~80 mm
Capacity: ~0.30 l

SERVICES

Packaging: see page 88

BRANDING / AREA

Outside	1	1c - 5c Print CMYK Print	190 x 75 mm
----------------	----------	-----------------------------	-------------

CARINA INSIDE

Image scale 1:2



2c Print

NEW



4c Print

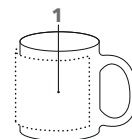

ART. NO. K004

Large stoneware mug

In straight design, high-gloss white with coloured interior glaze.

Height: ~95 mm
Diameter: ~80 mm
Capacity: ~0.30 l

SERVICES

Packaging: see page 88

BRANDING / AREA

Outside	1	1c - 5c Print	190 x 75 mm
----------------	----------	---------------	-------------

MUGS

kössinger
Mugs. Branded for you.

CARINA

Image scale 1:2



2c Print



NEW

PRINTED
IN
GERMANY

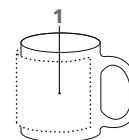

ART. NO. K003

Large stoneware mug

In straight-lined, timeless design.
High gloss coloured glaze.

Height: ~95 mm
Diameter: ~80 mm
Capacity: ~0.30 l

SERVICES

Packaging: see page 88

BRANDING / AREA

Outside	1	1c - 5c Print	190 x 75 mm
----------------	----------	---------------	-------------

CARINA GLAS

Image scale 1:2



1c Print
Glossy



1c Print
Glossy

NEW

PRINTED
IN
GERMANY

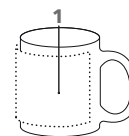

ART. NO. K016

Large glass

In mug shape.
Frosted.

Height: ~95 mm
Diameter: ~80 mm
Capacity: ~0.30 l

SERVICES

Packaging: see page 88

BRANDING / AREA

Outside	1	1c Print (Glossy)	186 x 75 mm
----------------	----------	-------------------	-------------

Opposite the handle there is a seam in the glass where a 5 mm area is excluded from the printing process.

CALI

Image scale 1:2

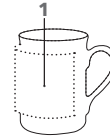

ART. NO. 0362

Stoneware mug

In classic design, high-gloss white

Height: ~ 105 mm
Diameter: ~ 79 mm
Capacity: ~ 0.25 l

SERVICES

Packaging: see page 88

BRANDING / AREA

Outside	1	CMYK Print	170 x 70 mm
----------------	----------	------------	-------------

SOLID

Image scale 1:2

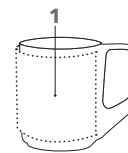

ART. NO. 0358

Stoneware mug

With unique handle, high-gloss white

Height: ~ 99 mm
Diameter: ~ 80 mm
Capacity: ~ 0.25 l

SERVICES

Packaging: see page 88

BRANDING / AREA

Outside	1	CMYK Print	180 x 80 mm
----------------	----------	------------	-------------

ELEKTRA WHITE

Image scale 1:2



ART. NO. 0354 / K005

Slim Stoneware mug

In elegant design,
High gloss white.

Height: ~99 mm
Diameter: ~82 mm
Capacity: ~0.25 l

SERVICES

Packaging: see page 88

BRANDING / AREA

Outside	1	1c - 5c Print CMYK Print	175 x 30 mm
----------------	----------	-----------------------------	-------------

ELEKTRA INSIDE

Image scale 1:2



ART. NO. 0355 / K006

Slim stoneware mug

In elegant design, high gloss white with
coloured interior glaze

Height: ~99 mm
Diameter: ~82 mm
Capacity: ~0.25 l

SERVICES

Packaging: see page 88

BRANDING / AREA

Outside	1	1c - 5c Print CMYK Print	175 x 30 mm
----------------	----------	-----------------------------	-------------

SOPHIA

Image scale 1:2



ART. NO. K015

Large porcelain mug

With distinctive handle.
High gloss white.

Height: ~ 100 mm

Diameter: ~ 97 mm

Capacity: ~ 0.38 l

SERVICES

Packaging: see page 88

BRANDING / AREA

Outside	1	1c - 5c Print	201 x 40 mm
---------	---	---------------	-------------

ENNIA WHITE

Image scale 1:2



ART. NO. K007

Modern stoneware mug

High-gloss white.

Height: ~ 85 mm

Diameter: ~ 80 mm

Capacity: ~ 0.25 l

SERVICES

Packaging: see page 88

BRANDING / AREA

Outside	1	1c - 5c Print	205 x 45 mm
---------	---	---------------	-------------

ENNIA INSIDE

Image scale 1:2



ART. NO. K008

Modern stoneware mug

In popular design. High-gloss white with coloured interior glaze.

Height: ~ 85 mm
Diameter: ~ 80 mm
Capacity: ~ 0.25 l

SERVICES

Packaging: see page 88

BRANDING / AREA

Outside	1	1c - 5c Print	205 x 45 mm
----------------	----------	---------------	-------------

ENNIA BLACK INSIDE

Image scale 1:2



ART. NO. K009

Modern stoneware mug in popular design and matt appearance.

Matt black with glossy coloured glaze inside.

Height: ~ 85 mm
Diameter: ~ 80 mm
Capacity: ~ 0.25 l

SERVICES

Packaging: see page 88

BRANDING / AREA

Outside	1	1c - 5c Print	205 x 45 mm
----------------	----------	---------------	-------------

CULT

Image scale 1:2



ART. NO. 0911 / 0324

Slim mug

in linear design, high-gloss white

Height: ~ 105 mm

Diameter: ~ 76 mm

Capacity: ~ 0.3 l

SERVICES

Packaging: see page 88

BRANDING / AREA

Outside	1	1c - 5c Print	165 x 70 mm
	2	CMYK Print	180 x 75 mm

COSMOS

Image scale 1:2



ART. NO. 0926 / 0356

Large porcelain mug

In modern, conical shape, high-gloss white

Height: ~ 107 mm

Diameter: ~ 95 mm

Capacity: ~ 0.33 l

SERVICES

Packaging: see page 88

BRANDING / AREA

Outside	1	1c - 5c Print	50 x 30 mm
	2	CMYK Print	190 x 80 mm

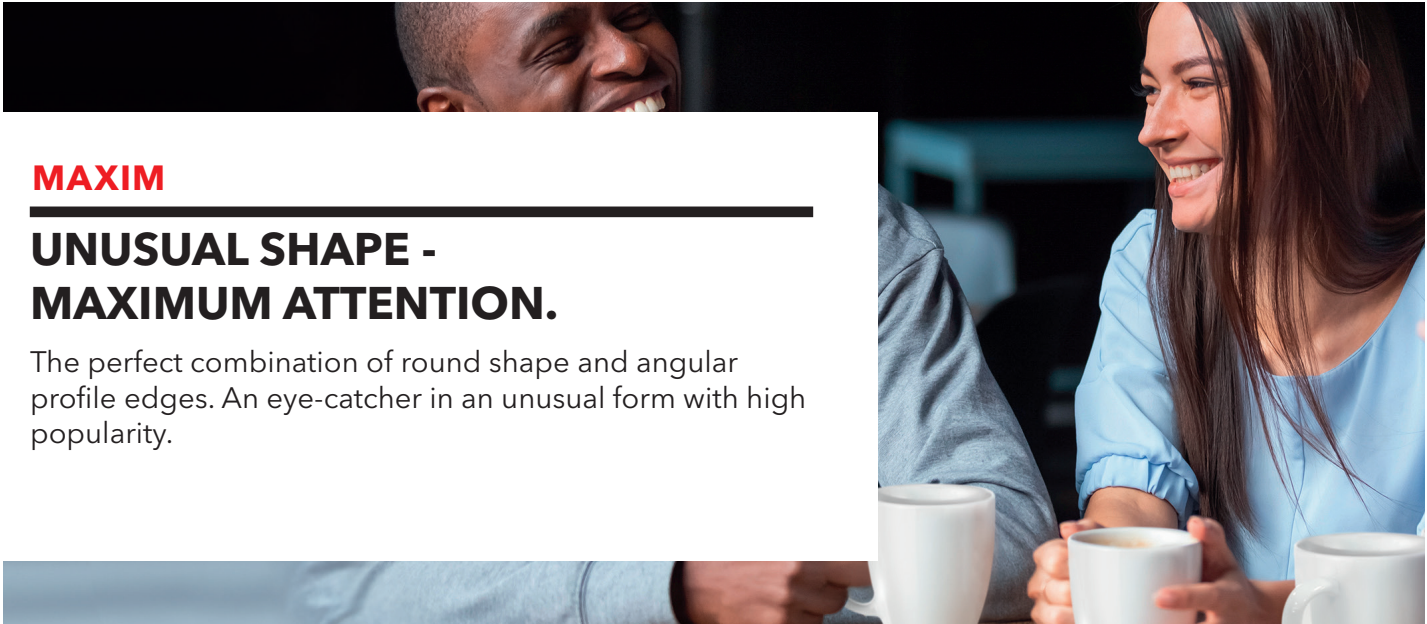

MAXIM

UNUSUAL SHAPE - MAXIMUM ATTENTION.

The perfect combination of round shape and angular profile edges. An eye-catcher in an unusual form with high popularity.

MAXIM

Image scale 1:2

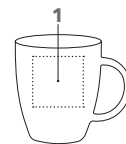

ART. NO. 0914

Porcelain mug

with unusual shape, high-gloss white

Height: ~ 99 mm

Diameter: ~ 86 mm

Capacity: ~ 0.3 l

SERVICES

Packaging: see page 88

BRANDING / AREA

Outside	1	1c - 5c Print	50 x 50 mm
----------------	----------	---------------	------------

MAXIM COFFEE CUP

Image scale 1:2



ART. NO. 0907

Small porcelain cup

With unusual shape, high-gloss white, suitable for coffee pod machines

Height: ~ 82 mm

Diameter: ~ 80 mm

Capacity: ~ 0.2 l

SERVICES

Packaging: see page 88

BRANDING / AREA

Outside	1	1c - 5c Print	40 x 50 mm
----------------	----------	---------------	------------

MAXIM COFFEE SET

Image scale 1:2



ART. NO. 0937

Coffee set

Porcelain cup with saucer, high-gloss white, suitable for coffee pod machines

Height: ~ 82 mm

Diameter: ~ 80 mm

Capacity: ~ 0.2 l

Diameter saucer: ~ 148 mm

BRANDING / AREA

Outside	1	1c - 5c Print	40 x 50 mm
saucer	2	1c - 5c Print	70 x 20 mm
	3	1c - 5c Print	Ø 35 mm

MUGS

kössinger
Mugs. Branded for you.

MAXIM ESPRESSO SET

Image scale 1:2

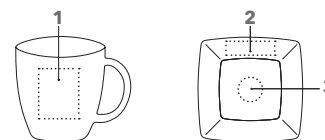

ART. NO. 0977

Espresso Set

Porcelain cup with saucer,
high gloss white

Height: ~ 55 mm

Diameter: ~ 60 mm

Capacity: ~ 0.08 l

Diameter saucer: ~ 116 mm

BRANDING / AREA

Outside	1	1c - 5c Print	30 x 40 mm
Saucer	2	1c - 5c Print	55 x 15 mm
	3	1c - 5c Print	Ø 25 mm

MAXIM PLATE

Image scale 1:2



ART. NO. 0927 / 0997 / 0998

Plate 0927

Porcelain, high gloss white

Diameter: ~ 210 mm

Dinner plate 0997

Porcelain, high gloss white

Diameter: ~ 260 mm

Soup plate 0998

Porcelain, high gloss white

Diameter: ~ 230 mm

BRANDING / AREA

0927	1	1c - 5c Print	70 x 25 mm
	2	1c - 5c Print	100 x 100 mm
0997	1	1c - 5c Print	100 x 20 mm
	2	1c - 5c Print	100 x 100 mm
0998	1	1c - 5c Print	80 x 20 mm
	2	1c - 5c Print	70 x 70 mm

MAXIM START-UP BOX

Image scale 1:3

1c Print

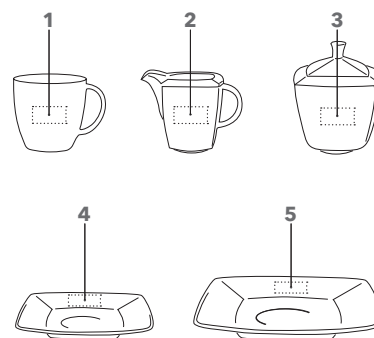

ART. NO. 0952

Porcelain set

74 pieces, white
suitable for coffee pod machines:
24 cups and saucers,
24 plates,
1 milk jug,
1 sugar bowl

Height cup: ~ 82 mm
Diameter cup: ~ 80 mm
Capacity cup: ~ 0.2 l
Diameter saucer: ~ 150 mm
Diameter plate: ~ 210 mm
Height milk jug: ~ 79 mm
Height sugar bowl: ~ 78 mm
(with lid ~ 115 mm)

BRANDING / AREA

Cup	1	1c - 5c Print	40 x 20 mm
Milk jug	2	1c - 5c Print	40 x 20 mm
Sugar bowl	3	1c - 5c Print	40 x 20 mm
Saucer	4	1c - 5c Print	40 x 20 mm
Plate	5	1c - 5c Print	40 x 20 mm

MUGS

kössinger
Mugs. Branded for you.



CAREFULLY PACKED. SAFE ON THE ROAD.

Senator® and kössinger mugs are packed in boxes of 36.
On request, we will be pleased to pack your mugs in individual cartons for individual distribution to your customers.

PACKAGING



ART. NO. P1A / P1A XL

Cardboard box P1A
white, for 1 mug

Dimensions: 125 × 90 × 120 mm

Cardboard box P1A XL
white, for 1 large mug

Dimensions: 130 × 110 × 120 mm

ART. NO. P36

Cardboard box
brown, for 36 mugs

Dimensions: 540 × 360 × 390 mm

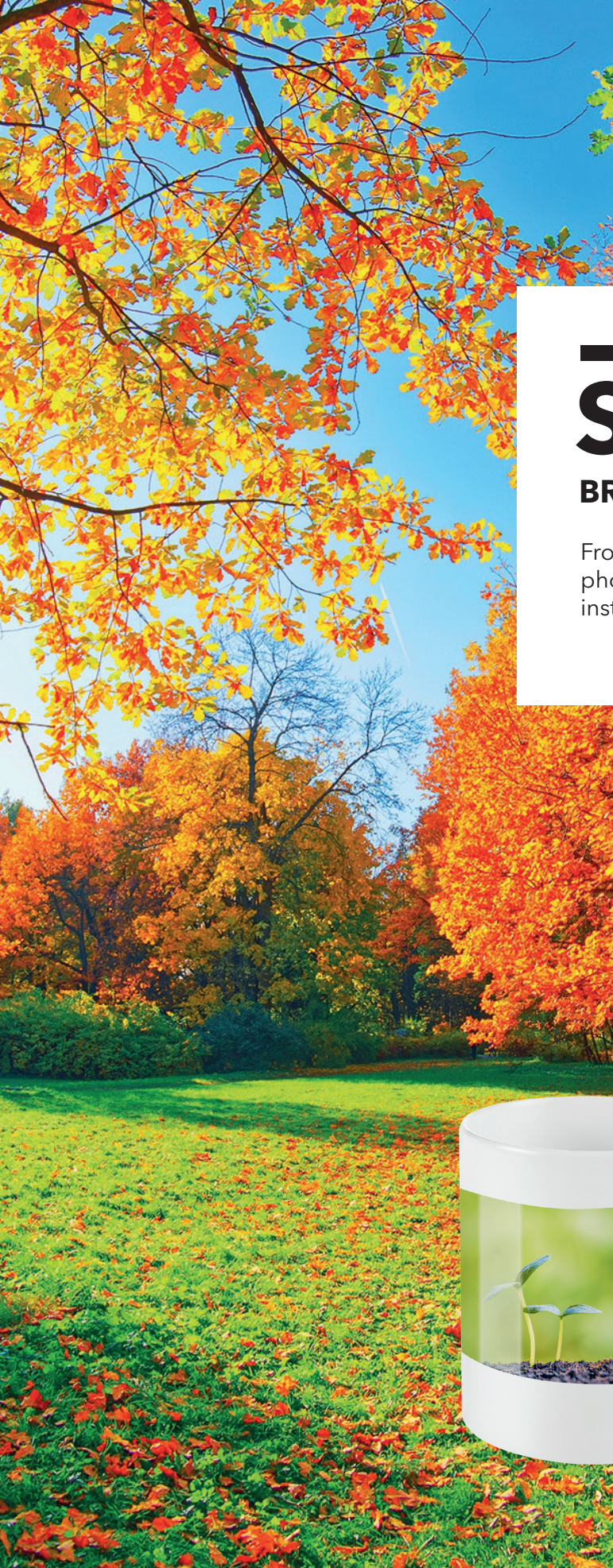

SERVICE

BRANDING AND MORE

From discreet single-colour logo printing to brilliant photorealistic CMYK printing, we brand your writing instruments and mugs. Versatile. Competent. Durable.



BRANDING METHODS

CMYK PRINT



DIGITAL PRINT

Our digital print is the perfect solution to apply multicoloured prints on the clips or barrels of our ball pens. With this method we also place logos very effectively onto the cap of our Liberty models.

Technology:

The digital print uses the CMYK colour printing process to mix all colours from the basic four. For prints on coloured backgrounds we apply an extra layer of white underneath the print.

Strengths:

- Print to the edge of the clip
- Realisation of colour gradients
- Also suitable for photo-realistic themes

DIGITAL PRINT WITH 3D EFFECT

On many white barrels of our writing instruments, large-area digital prints can be supplemented with a haptic effect. Give your brand presentation noticeably more structure and shine.

Technology:

The digital print uses the CMYK colour printing process to mix all colours from the basic four. An additional lacquer layer is added on top of the print for a high-gloss raised feel effect.
Minimum quantity: 1,000 pieces

Strengths:

- Incomparable 3D effect
- Realisation of complex colour gradients
- Reproduction of countless colours

1C - 5C PRINT



ENGRAVING



1C - 5C PRINT

Whenever it comes to branding our ball pen barrels, screen print is the branding method of our choice. For the curved clips, on the other hand, we use tampo printing. Both processes ensure optimal implementation of your brand message.

Technology:

Screen print is a direct print process whereby ink is pressed through a mesh onto the ball pen. Tampo print is an indirect print method whereby ink is transferred from the cliché via a silicone pad onto the surface to be printed.

Strengths:

- Particularly sharp-edged prints
- Accurate full colour prints possible
- Multicolour prints possible

LASER ENGRAVING

A very elegant branding method on metal surfaces. Logos or messages are very accurately and permanently worked into the metal surface.

Technology:

For our laser engraving we use a high precision computer-controlled laser which engraves the surface of our writing instruments and thus expose the metal layer underneath.

Strengths:

- A high-class and modest result
- Extremely durable
- Suitable for individual names

BRANDING METHODS

CMYK PRINT



SUBLIMATION

The sublimation process uses pressure and heat to transfer the graphic onto a specially coated mug.

We offer this impressive branding method for a total of 8 different mug designs and King Can.

Strengths:

- High colour variety and brilliance
- Photo realistic prints possible

1C - 5C PRINT



ENGRAVING



DIRECT PRINT

The direct printing process saves time and money. We print without raster and thus achieve rich, vibrant colours.

Technology:

The direct printing process does not require an intermediate step via a carrier material. The ink is applied directly to the mug without any detours.

Strengths:

- Short delivery times
- Cost-effective branding method
- Up to 5 colour prints possible

ENGRAVING

Engraving offers a high-quality and particularly durable finish. Logos or messages are very accurately and permanently worked into the metal surface.

Technology:



A computer-controlled laser engraves a logo or imprint into the item ensuring absolute definition and longlasting branding.

Strengths:

- Striking tactile results
- Understated quality
- Precise reproduction of logos and lettering

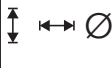

ARTICLE DATA

SENATOR PENS



Article	Model	Art. No.	Material	Ink colour	Refill magic flow 1.0 mm	 in mm	 in g	PU pieces	Page
MELBI	Melbi Matt Bio Recycled	3318	Recycled biobased Plastic	Blue/Black	G2	128 x 18 x 18	13.0	500	17
LIBERTY	Liberty Matt Bio	3310	Biobased plastic	Blue/Black	G2	145 x 15 x 11	9.34	1000	18
SKEYE BIO	Skeye Matt Bio	3290	Biobased plastic	Blue/Black	G2	150 x 15 x 12	13.1	500	19
NATURE PLUS	Nature Plus Matt Bio	2796	Biobased plastic	Blue/Black	G2	150 x 15 x 12	12.7	500	19
SUPER HIT	Super Hit Matt Bio	3300	Biobased plastic	Blue/Black	X20	141 x 11 x 15	8.5	1000	20
SUPER HIT	Super Hit Matt Recycled	3304	Recycelter Plastic	Blue/Black	X20	145 x 11 x 15	7.5	1000	20
TRENTO	Trento Matt Recycled	3305	Recycelter Plastic	Blue/Black	G2	149 x 12 x 15	9.8	500	21
LIBERTY	Liberty Matt Recycled	3307	Recycelter Plastic	Blue/Black	G2	145 x 15 x 11	8.7	500	22
CHALLENGER	Challenger Matt Recycled	3402	Recycelter Plastic	Blue/Black	G2	149 x 12 x 15	9.8	500	22
EVOXX	Evovx Duo Polished Recycled	3274	Recycelter Plastic	Blue/Black	G2	149 x 12 x 15	10.49	500	23
EVOXX	Evovx Polished Recycled	3273	Recycelter Plastic	Blue/Black	G2	149 x 12 x 15	10.49	500	23
DART	Dart Polished	2600	Plastic	Blue/Black	X20	143 x 10 x 14	6.9	1000	24
DART	Dart Polished Basic	2959	Plastic	Blue/Black	X20	143 x 10 x 14	6.9	1000	24
DART	Dart Clear	2602	Plastic	Blue/Black	X20	143 x 10 x 14	6.9	1000	25
SUPER HIT	Super Hit Polished	2883	Plastic	Blue/Black	X20	145 x 11 x 15	7.3	1000	25
SUPER HIT	Super Hit Polished Basic	2955	Plastic	Blue/Black	X20	145 x 11 x 15	7.3	1000	26
SUPER HIT	Super Hit Polished Basic SG	2956	Plastic	Blue/Black	X20	145 x 11 x 15	8.1	1000	26
SUPER HIT	Super Hit Clear SG	2234	Plastic	Blue/Black	X20	145 x 11 x 15	8.1	1000	27
SUPER HIT	Super Hit Clear	2756	Plastic	Blue/Black	X20	145 x 11 x 15	7.3	1000	27
SUPER HIT	Super Hit Frosted	2244	Plastic	Blue/Black	X20	145 x 11 x 15	7.5	1000	28
SUPER HIT	Super Hit Matt	2904	Plastic	Blue/Black	X20	145 x 11 x 15	7.5	1000	28
LIBERTY	Liberty Polished	2915	Plastic	Blue/Black	G2	145 x 15 x 11	8.7	1000	29
LIBERTY	Liberty Polished Basic	2993	Plastic	Blue/Black	G2	145 x 15 x 11	8.7	1000	29
LIBERTY	Liberty Soft Touch	2015	Plastic	Blue/Black	G2	145 x 15 x 11	9.1	1000	30
LIBERTY	Liberty Soft Touch MC	2942	Plastic	Blue/Black	G2	145 x 15 x 11	10.4	1000	30
CHALLENGER	Challenger Polished	2416	Plastic	Blue/Black	G2	149 x 12 x 15	9.8	500	32
CHALLENGER	Challenger Polished MT	2926	Plastic	Blue/Black	G2	149 x 12 x 15	13.5	500	33
CHALLENGER	Challenger Polished Basic SG	2958	Plastic	Blue/Black	G2	145 x 11 x 15	10.8	500	33
CHALLENGER	Challenger Frosted	2418	Plastic	Blue/Black	G2	149 x 12 x 15	9.8	500	34
CHALLENGER	Challenger Clear	2192	Plastic	Blue/Black	G2	149 x 12 x 15	9.8	500	34
CHALLENGER	Challenger Clear SG	2597	Plastic	Blue/Black	G2	149 x 12 x 15	10.8	500	35
CHALLENGER	Challenger Clear MT	2925	Plastic	Blue/Black	G2	149 x 12 x 15	13.5	500	36
CHALLENGER	Challenger Soft Touch	2737	Plastic	Blue/Black	G2	149 x 12 x 15	10.1	500	36
BRIDGE	Bridge Polished	3250	Plastic	Blue/Black	G2	141 x 17 x 11	10.3	500	37
BRIDGE	Bridge Polished MT	3252	Plastic	Blue/Black	G2	141 x 17 x 11	13.8	500	37

ARTICLE DATA

SENATOR PENS



Article	Model	Art. No.	Material	Ink colour	Refill magic flow 1.0 mm	 in mm	 in g	PU pieces	Page
BRIDGE	Bridge Clear	3251	Plastic	Blue/Black	G2	141 x 17 x 11	10.3	500	38
BRIDGE	Bridge Clear MT	3253	Plastic	Blue/Black	G2	141 x 17 x 11	13.8	500	38
BRIDGE	Bridge Soft Touch	3257	Plastic	Blue/Black	G2	141 x 17 x 11	10.4	500	39
HEADLINER	Headliner Polished Basic	3280	Plastic	Blue/Black	G2	141 x 11 x 15	10.5	500	40
HEADLINER	Headliner Clear Basic	3281	Plastic	Blue/Black	G2	141 x 11 x 15	10.5	500	40
HEADLINER	Headliner Soft Touch	3285	Plastic	Blue/Black	G2	141 x 11 x 15	10.5	500	41
POINT	Point Polished	3217	Plastic	Blue/Black	X20	137 x 9 x 17	7.9	1000	42
POINT	Point Metal	3317	Plastic	Blue/Black	G2	137 x 9 x 12	11.3	500	42
NEW SPRING	New Spring Polished MC	2310	Plastic	Blue/Black	G2	147 x 12 x 17	12.6	500	43
NEW SPRING	New Spring Clear MC	2410	Plastic	Blue/Black	G2	147 x 12 x 17	12.5	500	43
POLAR	Polar	3261	Metal	Blue/Black	G2	143 x 13 x 11	17.5	100	44
SIGNER LINER	Signer Liner	2709	Metal	Blue	G2	140 x 15 x 13	18.9	50	44

ROU BILL PENS





Article	Model	Art. No.	Material	Ink colour	Refill magic flow 1.0 mm	 in mm	 in g	PU pieces	Page
ARVENT	Arvent Glossy	3360	Metal	Blue	Metal, G2	144 x 14 x 10	15.59	250	46
ARVENT	Arvent Soft Touch	3365	Metal	Blue	Metal, G2	144 x 14 x 10	29.6	250	46
PHENIX	Phenix	3380	Metal	Blue	Metal, G2	140 x 15 x 12	37.0	250	47
ATTRACT	Attract	3330	Metal	Blue	Metal, G2	136 x 14 x 11	24.3	250	48
ATTRACT	Attract Soft Touch Touch Pad Pen	3335	Metal	Blue	Metal, G2	136 x 14 x 11	26.18	250	48
ARCTIC	Arctic	3390	Metal	Blue	Metal, G2	140 x 15 x 11	30.0	250	49
GALANT	Galant	3370	Metal	Blue	Metal, G2	138 x 13 x 11	25.2	250	49
STAR TEC	Star Tec Steel	2040	Metal	Blue	Metal, G2	133 x 14 x 10	17.0	250	50
STAR TEC	Star Tec Alu	2511	Metal	Blue	Metal, G2	133 x 14 x 10	5.96	250	50
NAUTIC	Nautic	1092	Metal	Blue	RB Metal	137 x 11 x 15	30.0	250	51
NAUTIC	Nautic	2215	Metal	Blue	Metal, G2	140 x 11 x 15	29.0	250	51
NAUTIC	Nautic Set	6297	Metal	Blue	Metal, G2 + RB	158 x 53 x 25	102.0	15	51
NAUTIC	Nautic Touch Pad Pen	2754	Metal	Blue	Metal, G2	140 x 11 x 15	28.0	250	52
NAUTIC	Nautic Black	3340	Metal	Blue	Metal, G2	145 x 11 x 15	28.0	250	52
IMAGE	Image Black Line	2636	Metal	Blue	Metal, G2	140 x 11 x 14	30.0	250	53
IMAGE	Image Black Line	1119	Metal	Blue	RB Metal	140 x 12 x 14	34.0	250	54
IMAGE	Image Black Line Set in ET156	6205	Metal	Blue	Metal, G2 + Nib M	168 x 68 x 28	142.0	50	54
IMAGE	Image Black Line Set in ET156	6206	Metal	Blue	Metal, G2 + RB	194 x 132 x 19	146.0	50	54
IMAGE	Image Black Line	0104	Metal	Blue	Nib M	139 x 12 x 14	30.0	250	54
IMAGE	Image White Line	1146	Metal	Blue	RB Metal	140 x 12 x 14	34.0	250	55

ARTICLE DATA

SENATOR PENS





Article	Model	Art. No.	Material	Ink colour	Refill magic flow 1.0 mm	 in mm	 in g	PU pieces	Page
IMAGE	Image White Line	2786	Metal	Blue	Metal, G2	140 x 11 x 14	30	250	55
IMAGE	Image White Line Set in ET156	6267	Metal	Blue	Metal, G2 + RB	168 x 68 x 28	154	50	55
IMAGE	Image Chrome	1036	Metal	Blue	RB Metal	140 x 12 x 14	33	250	56
IMAGE	Image Chrome	2158	Metal	Blue	Metal, G2	140 x 11 x 14	31	250	56
IMAGE	Image Chrome Set in ET156	6238	Metal	Blue	Metal, G2 + RB	168 x 68 x 28	148	50	56
CARBON	Carbon Line Black	3350	Metal	Blue	Metal, G2	150 x 11 x 14	37	250	57
CARBON	Carbon Line	2159	Metal	Blue	Metal, G2	150 x 11 x 14	37	250	58
CARBON	Carbon Line	1037	Metal	Blue	RB Metal	143 x 11 x 14	43	150	59
CARBON	Carbon Line Set in ET160	6240	Metal	Blue	Metal, G2 + RB	193 x 82 x 40	280	20	59
CARBON	Carbon Line Set in ET160	6239	Metal	Blue	Metal, G2 + Nib M	193 x 82 x 40	275	20	59
CARBON	Carbon Line	0076	Metal	Blue	Nib M	143 x 11 x 14	39,4	150	59
TIZIO	Tizio	2400	Metal	Blue	Metal, G2	143 x 11 x 14	6,1	250	60
TIZIO	Tizio Set in ET160	6253	Metal	Blue	Metal, G2 + RB	195 x 85 x 40	275	20	61
TIZIO	Tizio Set in ET160	6252	Metal	Blue	Metal, G2+ Nib M	195 x 85 x 40	275	20	61
TIZIO	Tizio	1240	Metal	Blue	RB Metal	143 x 11 x 14	43	300	61
TIZIO	Tizio	0240	Metal	Blue	Metal, G2+ Nib M	144 x 11 x 14	37,31	250	61

SENATOR MUGS

Article	Model	Art. No.	Material	 in ltr.	 in mm	 in mm	 in g	PU pieces	Page
AMITY	Amity	0321	Porcelain	0.25 l	85	80	268	36	66
FRIEDA	Frieda	K011	Porcelain	0.25 l	78	100	340	36	66
PRIME	Prime	0341	Porcelain	0.25 l	106	73	302	36	67
CHARISMA	Charisma	0915	Porcelain	0.25 l	106	82	266	36	67
ELEGANT	Elegant	0381	Porcelain	0.30 l	92	86	287	36	68
ELITE	Elite	0912	Porcelain	0.25 l	100	80	261	36	68
MAXI MUG	Maxi Mug	0344	Porcelain	0.25 l	100	82	391	36	69
APPEAL	Appeal	0928	Porcelain	0.40 l	95	100	314	36	69
FANCY	Fancy Espresso Set	0964	Porcelain	0.09 l	65	83	197	12	70
FANCY	Fancy Coffee Cup	0965T	Porcelain	0.20 l	57	67	179	36	70
FANCY	Fancy Coffee Set	0965	Porcelain	0.20 l	65	83	328	12	70
FANCY	Fancy Plate	0966	Porcelain	-	19	213	326	12	71
FANCY	Fancy Dinner Plate	0993	Porcelain	-	19	260	477	12	71
FANCY	Fancy Soup Plate	0994	Porcelain	-	35	225	394	12	71
FANCY	Fancy Bowl	0920	Porcelain	0.65 l	79	141	434	36	71
FANCY	Fancy Start-Up Box, 74 pcs.	0951	Porcelain	-	-	-	18500	1	72

ARTICLE DATA

KÖSSINGER MUGS

Article	Model	Art. No.	Material	 in ltr.	 in mm	 in mm	 in g	PU pieces	Page
KING CAN	King Can	0755	Stainless Steel	0.33 l	149	71	197	36	74
KING CAN	King Can	0765	Stainless Steel	0.33 l	150	71	197	36	74
KING CAN	King Can Mini	0785	Stainless Steel	0.26 l	127	71	157	36	75
TROPHY	Trophy	0750	Stainless Steel	0.4 l	175	82	274	36	75
OUTDOOR	Outdoor	0372	Stainless Steel/Enamel	0.30 l	81	87	134	36	76
CARINA	Carina White	0323	Stoneware	0.30 l	96	82	331	36	77
CARINA	Carina White	K002	Stoneware	0.30 l	80	95	310	36	77
CARINA	Carina Inside	K004	Stoneware	0.30 l	80	95	270	36	77
CARINA	Carina	K003	Stoneware	0.30 l	80	95	310	36	78
CARINA	Carina Glas	K016	Glass	0.30 l	80	95	300	36	78
CALI	Cali	0362	Stoneware	0.25 l	105	79	323	36	79
SOLID	Solid	0358	Stoneware	0.25 l	99	80	336	36	79
ELEKTRA	Elektra White	0354	Stoneware	0.25 l	99	82	278	36	80
ELEKTRA	Elektra White	K005	Stoneware	0.25 l	78	100	340	36	80
ELEKTRA	Elektra Inside	K006	Stoneware	0.25 l	78	100	340	36	80
ELEKTRA	Elektra Inside	0355	Stoneware	0.25 l	78	100	340	36	80
SOPHIA	Sophia	K015	Porcelain	0.38 l	97	100	310	36	81
ENNIA	Ennia White	K007	Stoneware	0.25 l	90	85	340	36	81
ENNIA	Ennia Inside	K008	Stoneware	0.25 l	80	85	360	36	82
ENNIA	Ennia Black Inside	K009	Stoneware	0.25 l	80	85	360	36	82
CULT	Cult	0324	Stoneware	0.30 l	105	76	325	36	83
CULT	Cult	0911	Porcelain	0.25 l	104	73	288	36	83
COSMOS	Cosmos	0926	Porcelain	0.33 l	106	94	330	36	83
COSMOS	Cosmos	0926	Porcelain	0.33 l	107	95	351	36	83
MAXIM	Maxim	0914	Porcelain	0.30 l	99	85	272	36	84
MAXIM	Maxim Coffee Cup	0907	Porcelain	0.20 l	82	79	189	36	85
MAXIM	Maxim Coffee Set	0937	Porcelain	0.20 l	70	79	378	36	85
MAXIM	Maxim Espresso Set	0977	Porcelain	0.08 l	57	60	183	12	86
MAXIM	Maxim Plate	0927	Porcelain	-	25	210	462	12	86
MAXIM	Maxim Dinner Plate	0997	Porcelain	-	25	260	841	12	86
MAXIM	Maxim Soup Plate	0998	Porcelain	-	41	230	582	12	86
MAXIM	Maxim Start-Up Box, 74 pieces	0952	Porcelain	-	405	-	24500	1	87

ARTWORK

GENERAL INFORMATION

Please send us your artwork in the below mention file types or send text in on of our standard typefaces.

Please also provide a print sample or proof if possible.

Please send logos and text as vectorised files or as TIF-files with 1200 dpi, in case of photos we require a resolution of 600 dpi.

Vectorised logos can be scaled without any loss in quality and are to be preferred against pixel files.

Below mentioned minimum font sizes and minimum line widths are guidelines only. Depending on the motive, branding method or product surface smaller letters and finer lines might be possible or larger letters or bigger lines might be necessary.

Proof samples

To make sure you get the best possible result we recommend the production of a sample for approval. (For production reasons slight colour deviations between a print on paper and a print on other materials are unavoidable).

File formats

Adobe Photoshop CC 2023

Adobe Illustrator CC 2023

Adobe Indesign CC 2023

Corel Draw X8

(Please convert all texts into curves)

PENS

Print colours

With the available colour shade mixing range, all Pantone C and HBP K shades can be mixed. Slight colour shade deviations between paper flags and print are unavoidable on white underground. Major colour shade deviations on an underground of a different colour shade or on a dark-shaded underground must be tolerated.

Digital print

All colours are mixed in CMYK, so it is not possible to print real PMS colours. In nearly every case the colours will be close to. Very large, uni coloured surfaces cannot be realised. Minimum size: 8 pt, minimum line width: 0.15 mm

Laser engraving

Minimum line width: 0.15 mm, Minimum front size: 6 pt

Personalisation (list of names)

Many of our products can be customised with the personal name. Please send us the names in an excel file.

Raster

Screen print: Raster of 40, colour intensity 15 - 85%.

360° barrel print: Raster of 48, colour intensity 15 - 85%

Standard Typefaces

Arial, AvantGarde, Courier, Futura, Present, Serifa, Helvetica, Times New Roman, Unifers each regular, bold, italic, bold italic, BrushScript, English script tye each italic and bold italic. Other typefaces possible (only PC), please send font as True Type-face (*.ttf).

Other or similar typefaces on request.

MUGS

Direct Print

Minimum size 10 pt, minimum line width 0.2 mm, no raster

Due to their nature, the printing colours are not completely opaque. This means that the colour will generally appear darker on dark backgrounds.

Transfer print

Minimum size 8 pt, minimum line width 0.2 mm, printable colour intensity 15 - 85 %

Personalisation (list of names)

A great variety of our mugs can be customised with the personal name. Please send us the names in an excel file. Please note that this very special way of customisation is always possible when the name stands for itself and is not part of the remaining design.

3 X 3 GOOD REASONS FOR SENATOR

Made in Germany

- Development, production and printing in Germany
- Refill production at our own premises
- In-depth knowledge of all processes and materials used

Sustainability

- Reuse of production waste
- Superior ecological footprint compared to imported products
- Short transport distances from production to the customer

Responsibility

- Regular certification according to ISO 9001 and ISO 14001
- SEDEX membership
- Declarations of conformity for all products

